



## Nonlinear Finite Elements Analysis of Circular Reinforced Concrete Columns Strengthened With Carbon Fiber Reinforced Polymer (CFRP)

Zahraa Abbas Khaduer and Mazen Dewan Abdulla

Civil Engineering Department, Engineering College, University of Basrah, Iraq

### ARTICLE INFO

Received: 20/10/2017

Accepted: 06/01/2018

### Keywords

Carbon Fiber Reinforced Polymer; Circular columns; Confined concrete; Non-linear finite element analysis; Ductility.

### ABSTRACT

This paper presents the results of a study to have better understanding of structural behavior of the reinforced concrete (RC) column wrapped by carbon fiber reinforced polymer (CFRP) sheets.

In this study, three dimensional finite element models have been presented using ANSYS computer program (Release 16.0) to analyze reinforced concrete columns strengthened with CFRP composites, to evaluate the gain in performance (strength and ductility) due to strengthening, and to study the effect of the most important parameters such as: compressive strength of concrete, modulus of elasticity of CFRP and fiber orientations.

Three dimensional eight-node brick element (SOLID65) was used to represent the concrete, and three dimensional spar element (LINK180) was used to represent the steel and three dimensional shell element (SHELL41) was used to represent the CFRP composites.

The present study has a comparison between the analytical results from the ANSYS finite element analysis with experimental data. The results of the study show that, external bonded CFRP sheets are very effective in enhancing the axial strength and ductility of the concrete columns. Inspection of the results shows that, there is good agreement between the ANSYS and the experimental test results.

\*Corresponding author:

E-mail addresses: (zahraabas1992@gmail.com)

©2019 AL-Muthanna University. All rights reserved.

DOI:10.52113/3/eng/mjet/2019-07-01/10-22

## INTRODUCTION

Fiber Reinforced Polymer (FRP), an incorporation of fibers and a matrix, are used as Carbon Fiber (CF), Aramid Fiber (AF) and Glass Fiber (GF) reinforced materials. Strengthening and repairing of reinforced concrete structural elements by using externally bonded Carbon Fiber Reinforced polymer (CFRP) sheets are particularly suitable due to the superior properties of CFRP sheets against corrosion, chemicals and environmental attack. Also, the simplicity of using externally bonded CFRP sheets in application in a wide variety without any difficulties, which is considered from the principals when applying the alternative techniques e.g. steel plate technique. Moreover, CFRP sheets are very easy to be cut and swathed in order to be applied as either closed stirrups or U-jacket strips.

Concrete columns have an substantial role in the structural concept of many structures. Oftentimes columns are disqualified to load increase (increasing loads or change of structures' function, etc.), exceptional loads (such as: impact; explosion or seismic loads) and degradation (corrosion of steel reinforcement, alkali silica reaction, etc.). Confining of concrete elements by means of wrapping CFRP sheets is considered very efficient to enhance both load carrying capacity and structural ductility of R.C. columns subjected to axial compression load. Also, the structural performance and simplicity of application of the externally bonded CFRP sheets has been observed. Several research programs and practical applications have been demonstrated that strengthening concrete columns by means of CFRP wrapping sheets is an attractive technique [Saadatmanesh et al. 1994].

When the FRP-wrapped concrete is submitted to an axial compression loading, the concrete core enlarges laterally. FRP wrap shows an opposite reaction to the lateral expansion, making the concrete core changed to a three dimensional compressive stress state. In this state, confinement pressure has significant influence on performance of the concrete core [Parvin, Jamwal 2005].

Several parameters influence the confinement effectiveness of the FRP wrap, which include concrete compressive strength, number of FRP layers (wrap thickness), and angle orientation of wrapping. [Sadeghian et al. 2007]

Many investigations have been conducted into FRP-wrapped concrete behavior. Fibers should be aligned along the hoop direction to confine the dilation of the concrete core when a column subjected to a uniaxial compressive load. In practice, almost all the columns are subjected to a uniaxial compressive load and a bending moment when the columns loaded with an eccentric axial load. As a result of this, almost all the columns

should be treated as beam-columns. For beam-column, fiber orientation with hoop direction is the optimal for only uniaxial compressive load; for a bending moment, axial direction is the favorable fiber orientation. Therefore, fiber orientation is an important parameter in the structural design of FRP-wrapped concrete columns. [Rochette, Labossiere 2000]

In this paper, concentration are on applications of carbon fibers (CFRP) wraps with different fiber orientations and layers thickness to demonstrate the effect on the axial strength and ductility of circular concrete columns.

## CONFINEMENT MECHANISM OF STRENGTHING CONCRETE COLUMN

Application FRP jackets or any confining device (steel plates, transverse reinforcing steel) to the concrete column, at first, no initial stresses are inserted in the confining device at low levels of stresses in the concrete; therefore the concrete is considered as unconfined. But at advanced stages of stresses approaching to the uniaxial concrete strength, lateral expansion of concrete and progressive internal cracking lead to increase the transverse strains; therefore, the concrete tried to spread out against the confining device, and the last then will be activated and prevents the lateral expansion by initiated a reverse reaction to the concrete making it in triaxial compressive stress state and according to that , the strength and the ductility of concrete are greatly increased. This type of confinement is passive and that confinement may be constant or variable through an axial load history. Confinement by elastic plastic material such as conventional mild transverse reinforcing steel will produce a constant confining pressure after yielding.

Tests have demonstrated that the circular section of a concrete column is much effective than square and rectangular sections in confinement , the reason of this difference in effectiveness is illustrated in Fig.(1) shows that a circular section because of its shape will make the confinement device in hoop tension and make it provide a continuous confining pressure around the circumference of column resulting in complete confinement. On the other hand, the square or rectangular section makes the confinement device apply confining reaction only near the corners and the central region of the section and leaves the sides without confinement which leads to provide partial confinement for the column.

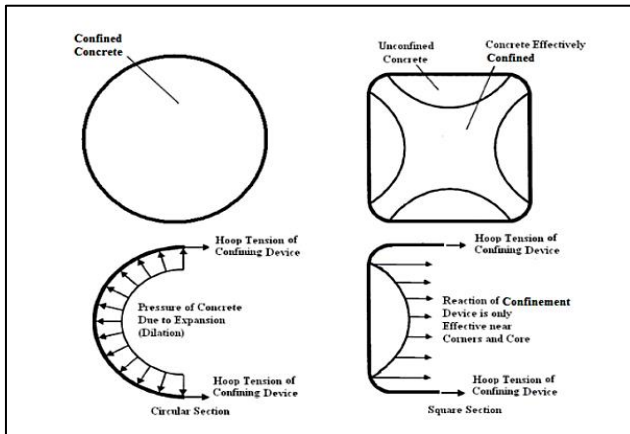

Figure1. confinement influence for circular and square sections.

### GENERAL BEHAVIOR OF STRENGTHENED BY FRP

As shown in Fig.(2), axial stress-strain curves of the upper two curves of concrete passively confined by FRP are basically consisted of two parts with a small transition zone start at first point when the slope change. The elastic zone is the first portion of the curve to the left of the transition zone while the second portion to the right will be referred to the plastic zone.

The slope of elastic portion of the confined concrete curves is exactly the same to that of unconfined concrete . Jacket type with which the concrete is confined has little effect on this portion of the curve, except that a stiffer jacket tends to increase the stress and strain at which the transition zone occurs .The stress-strain curve of unconfined concrete is plotted with the confined concrete curves for comparison.

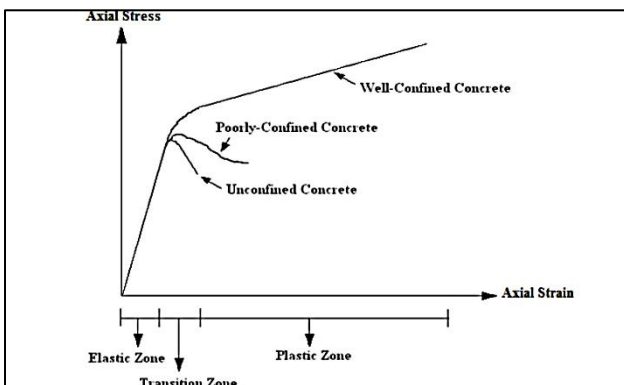

Figure 2. Axial stress- axial strain curves for concrete confined by FRP.

The confined and unconfined curves are very similar in the elastic zone that because the concrete receives little expansion under small loads and thus does not react against the jacket to produce confinement pressure.

When the peak strength of the unconfined concrete reaches, the plastic zone has been occurred shortly after . At this point, the jacket has fully activated due to concrete expansion. In the plastic zone, a large increase in lateral expansion happened due to a small increase in stress (relative to the elastic zone) .This expansion produces two actions. First; causing the deterioration of the internal structure of the concrete. Second, increase in confining pressure, since the jacket's fiber display linear elastic behavior until failure. These two actions help to define the slope of the plastic portion of the curve. If the concrete is well confined ,then the slope will be positive and usually quite linear, indicating that the confining pressure is sufficient to reduce the impact of the degraded state of the concrete and allows greater pressure to be applied. If the concrete is not well-confined, then the peak axial stress will be similar to that of unconfined concrete ,indicating that the confining pressure is not sufficient to overcome the effect of the degradation of the concrete under the large strains[Cole, Belarbi, 2001].

### REPRESENTATION OF STRENGTHENED REINFORCED CONCRTE BY FINITE ELEMENT

The wide dissemination of computers and the development of the finite element method have provided instruments for analysis of much more complex of reinforced concrete members in a much more realistic way, Although the traditional empirical methods remain adequate for analysis . A nonlinear finite element analysis has been carried out for the analysis of reinforced concrete columns strengthen with CFRP composite. Finite element program ANSYS (Version 16.0) was used in this study. Solid 65, Solid 185 , Link 180 and Shell 41 , elements are used to represent concrete, steel plates, main steel and stirrups reinforcing bars and carbon fiber (CFRP) composites respectively. The geometry, locations of node, and the coordinate system for ANSYS elements are shown in Fig. (3).

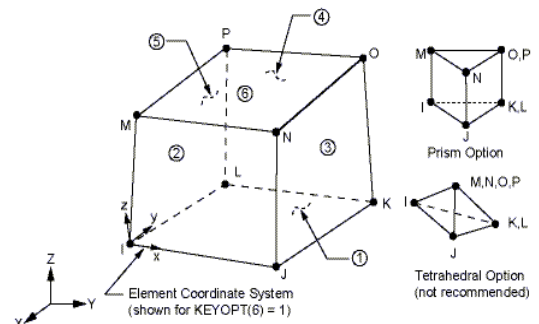

a. Brick Element SOLID 65.

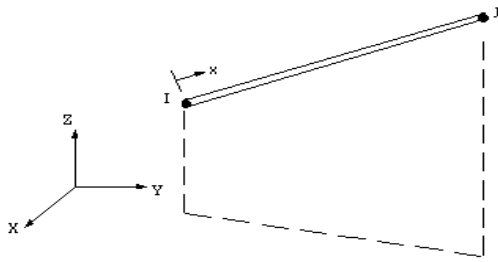

b. Link 180 3D Spar.

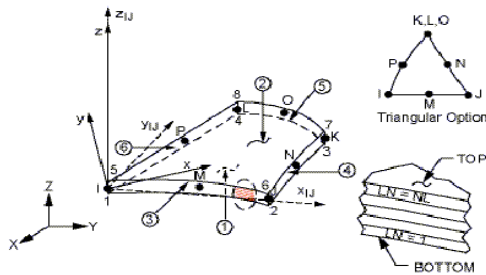

c. Shell 41 Geometry.

Figure 3. Geometry of ANSYS elements, ANSYS (2016).

STRESS-STRAIN RELATIONSHIP FOR CONFINED CONCRETE

The stress-strain relationship for confined concrete under uniaxial compressive stress used in this study was obtained by [Mander et al. 1988]. Elastic modulus of the concrete corresponds to the slope of the first part of the curve and no other part has larger slope. [Mander et al.1988] proposed a stress-strain model for confined and unconfined concrete subjected to uniaxial compressive stress (Fig. 4), and is given by the following relationships:

$$f_c = \frac{f'_{cc} x^r}{r - 1 + x^r} \dots \dots \dots (1)$$

Where:

$$x = \frac{\epsilon_c}{\epsilon_{cc}} \dots \dots \dots (2)$$

$\epsilon_c$  : Axial compressive concrete strain

$$\epsilon_{cc} = \epsilon_{co} \left[ 1 + 5 \left( \frac{f'_{cc}}{f'_{co}} - 1 \right) \right] \dots \dots \dots (3)$$

$f_c$ : Longitudinal compressive concrete stress

$\epsilon_{co}$ : Unconfined concrete strain

$f'_{co}$  : Unconfined concrete strength

$f'_{cc}$ : Confined concrete strength

$$r = \frac{E_c}{E_c - E_{sec}} \dots \dots \dots (4)$$

$$E_c = 5000 \sqrt{f'_{co}} \text{ MPa} \dots \dots \dots (5)$$

$$E_{sec} = \frac{f'_{cc}}{\epsilon_{cc}} \dots \dots \dots (6)$$

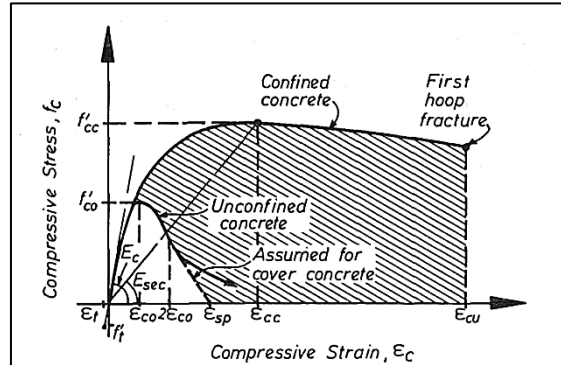

Figure 4. Stress-Strain model for confined and unconfined concrete, [Mander et al. 1988].

$$f'_{cc} = f'_{co} \left( -1.254 + 2.254 \sqrt{1 + \frac{7.94 f'_l}{f'_{co}}} - 2 \frac{f'_l}{f'_{co}} \right) \dots \dots \dots (7)$$

The effective lateral confined stress on the concrete in x, y directions are:

$$f'_{lx} = k_e p_x f_{yh} \dots \dots \dots (8)$$

And

$$f'_{ly} = k_e p_y f_{yh} \dots \dots \dots (9)$$

$$p_x = \frac{A_{sx}}{s d_c} \dots \dots \dots (10)$$

$$p_y = \frac{A_{sy}}{s b_c} \dots \dots \dots (11)$$

Where:

$f_{yh}$ : yielding stress of transverse reinforcement,

$A_{sx}$ ,  $A_{sy}$ = total area of the transverse bars running in the x and y directions, respectively,  $b_c$ ,  $d_c$  the core dimension from c/c perimeter hoops in x, y directions, respectively, where  $b_c \geq d_c$ , s: distance between ties, center to center.

$$K_e = \frac{(1 - \sum_{i=1}^n \frac{(w'_i)^2}{6 b_c d_c}) (1 - \frac{s'}{2 b_c}) (1 - \frac{s'}{2 d_c})}{(1 - p_{cc})} \dots \dots \dots (12)$$

Where:

$s'$ : is a clear spacing between ties hoops,  $w'_i$ : the clear distance between adjacent longitudinal bars, and  $p_{cc}$ : ratio of area of longitudinal reinforcement to area of core.

MATERIAL CHARACTERISTICS:

Finite element models for CFRP confined columns are presented. First the material characteristics are identified, then material properties which are required to insert in software are defined. In this study, the ANSYS is used for modeling of concrete column, reinforcement and CFRP sheet.

The nonlinear analysis is developed by means of ANSYS/STANDARD to simulate the nonlinear behavior of the confined column. After whole model geometry definition, the material properties should be introduced. First, elastic behavior of material is set. Hence, the elastic parameters such as: Young's modulus of concrete,  $E_c$  and Poisson's ratio,  $\nu$ , are inputted. From experimental results  $E_c$  is calculated as  $E_c = 4700\sqrt{f'_c}$  where  $f'_c$  is given in MPa. The popular stress-strain relationship is used to make the uniaxial compressive simulation of the concrete column which is given by [Mander et al.(1988)] as explained previously.

Poisson's ratio of concrete is assumed to be  $\nu_c=0.2$ . Also an elastic, perfectly plastic behavior is considered for the steel bars as recommended in several previous researches. The elastic modulus,  $E_s$  and yield stress,  $f_y$ , as measured in experimental tests. A Poisson's ratio of 0.3 is used for the steel reinforcement. The perfect bond between steel bars and concrete is considered. Indeed, as the CFRP behavior is orthotropic, the CFRP material is inputted as a linear elastic orthotropic material in the model. Indeed, it is necessary to introduce properties of the CFRP for each direction separately.

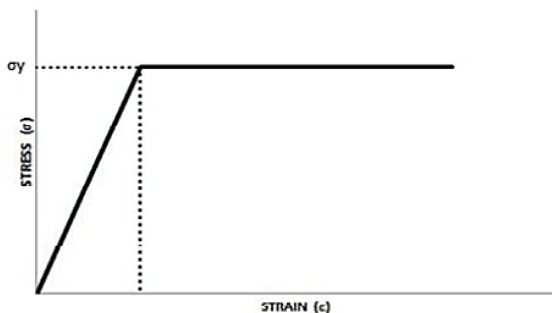

Figure 5. Stress-Strain relationship for steel as used in ANSYS.

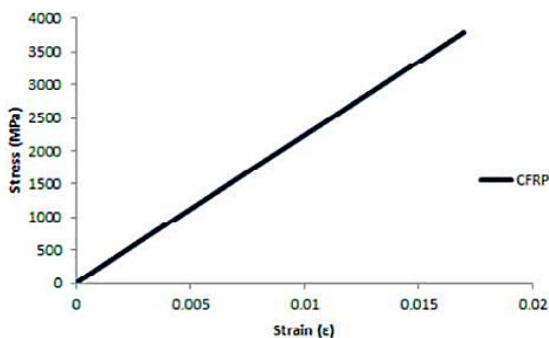

Figure 6. CFRP stress-strain relationship.

DETAILS OF STUDY

In the present study, the structural behavior of circular reinforced concrete columns strengthening with carbon fiber reinforced polymers is simulated depends on available experimental works. Thirty five cylindrical column specimens were analyzed by using FEM. First, verification study is done to check the validity of the theoretical results with experimental tests, then parametric study is done to investigate the effect of the most important parameter on performance of circular RC columns strengthen with CFRP composites.

In order to verified the circular cross section columns ,the experimental specimens were taken from [Wang et al. 2011] for both plain and reinforced concrete columns. In this section , six concrete columns with large-scale circular cross section confined with CFRP were selected to investigate the influence of sectional dimensions, internal steel reinforcement and thickness of CFRP jackets(number of layers) on the stress-strain behavior. Comparison between the analytical results from the ANSYS finite element analysis with experimental data for six specimens was done. The analytical results show good convergence with the experimental results. Results indicated that the confinement by CFRP resulted in significant increase in axial stress and strain for circular RC columns.

Six concrete columns strengthened with CFRP were selected from the test to be analyzed by the finite element method. Two of which had plain concrete( $f'_c=24.5$  MPa) denoted as (C1H0 ,C2H0) for two size ( $D=305$  and  $D=204$ ) and the other had varying volumetric ratios of hoops of 0.5% denoted as (C3H1,C4H1) and 1.0%, denoted as (C5H2 and C6H2). The reinforcement details of the columns are given in Table (1) and Fig. (7).Mechanical properties for steel and CFRP materials are given in Table (2).

Table 1. Details of the circular columns.

Specimens	D (mm)	H (mm)	Long. steel reinf.	volumetric ratio of hoops	$t_f$ (CFRP)
C1H0	305	915	--	--	0.167
C2H0	204	612	--	--	0.167
C3H1	305	915	8 $\phi$ 12	1.0%	0.334
C4H1	204	612	6 $\phi$ 10	1.0%	0.167
C5H2	305	915	8 $\phi$ 12	0.5%	0.334
C6H2	204	612	6 $\phi$ 10	0.5%	0.167

Where D= Diameter of cross section ;H= the height of specimens;  $t_f$ = thickness of CFRP

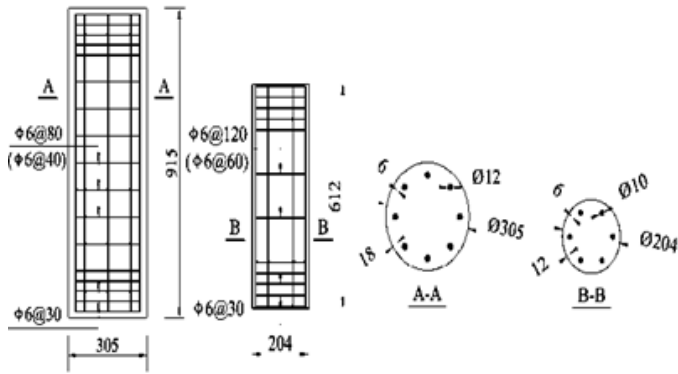

Figure 7. Details of reinforcement and specimen's dimensions.

Table 2. Material's properties.

Compressive strength ( f'c ) [Mpa]		24.5
Yield stress of longitudinal steel [MPa]	Ø12	340
	Ø10	312
Yield stress of lateral steel [MPa] Ø6		397
CFRP	Modulus of elasticity [GPa]	240
	Tensile strength [MPa]	4340
	Ultimate strain [%]	1.5
	Thickness [mm]	0.167

### ANALYSIS WITH FINITE ELEMENT:

The finite element method was applied to the six columns. The concrete of columns was modeled by SOLID65 element, all steel reinforcement was modeled by LINK180 element and CFRP sheets were modeled by SHELL41 element (perfect bond between concrete and FRP composites was assumed) and steel plates modeled by (SOLID185) at support and load positions , the coordinate system of the column specimen was defined in global directions where the bottom face of the column lies in the x-z plane and the positive y-axis is line up with the axis of the column . The bottom

face of the column was completely fixed (zero displacements and rotations on all nodes at  $y = 0$ ). All nodes were received a pressure load on the top face ( $y=$  height) of the column in a single load step. The load was applied in several sub- steps in such a way that it gradually increases at a constant rate from zero to a predefined final load. Fig. (8) shows the finite element mesh of the column , the boundary conditions and the applied pressure while fig. (9) show the whole finite element model and element mesh of steel and CFRP elements in ANSYS program. The models were carried out using (displacement convergence criterion) with tolerance of (5%), and full Newton-Raphson method.

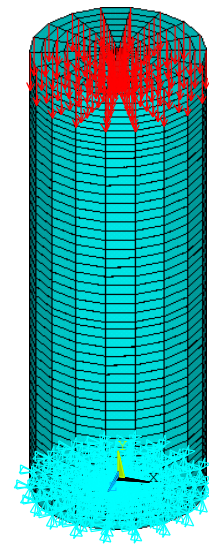

Figure 8. Finite element model , boundary condition and applied pressure.

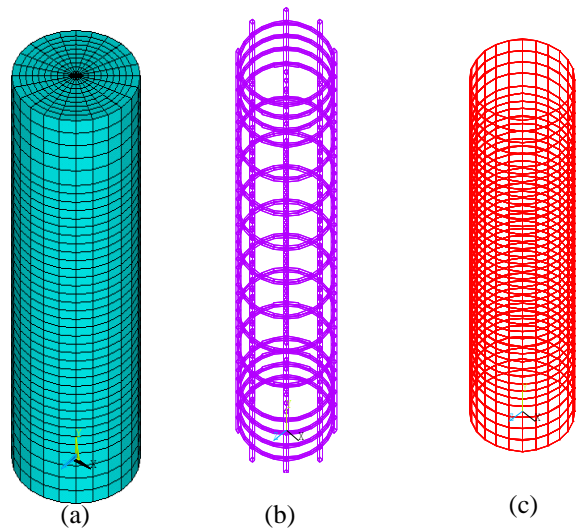

Figure 9. (a) Finite element model for column (b) steel elements (c) Mesh of CFRP.

RESULTS OF THE ANALYSIS:

The results were summarized in Table (3). It can be seen that both the axial stresses and strains for CFRP-confined circular columns have been enhanced due to the lateral confinement of external CFRP jacketing.

Axial stress-axial strain curves of columns obtained from the numerical analysis along with the experimental curves reported by [Wang et al.2011] are presented and compared in Fig. (10). These figures show good agreement between the experimental and finite element stress-strain results while Fig. (11) presented the results of ANSYS for these models. The results showed that the stress - strain behavior of all CFRP-confined circular RC columns were monotonically ascending curves.

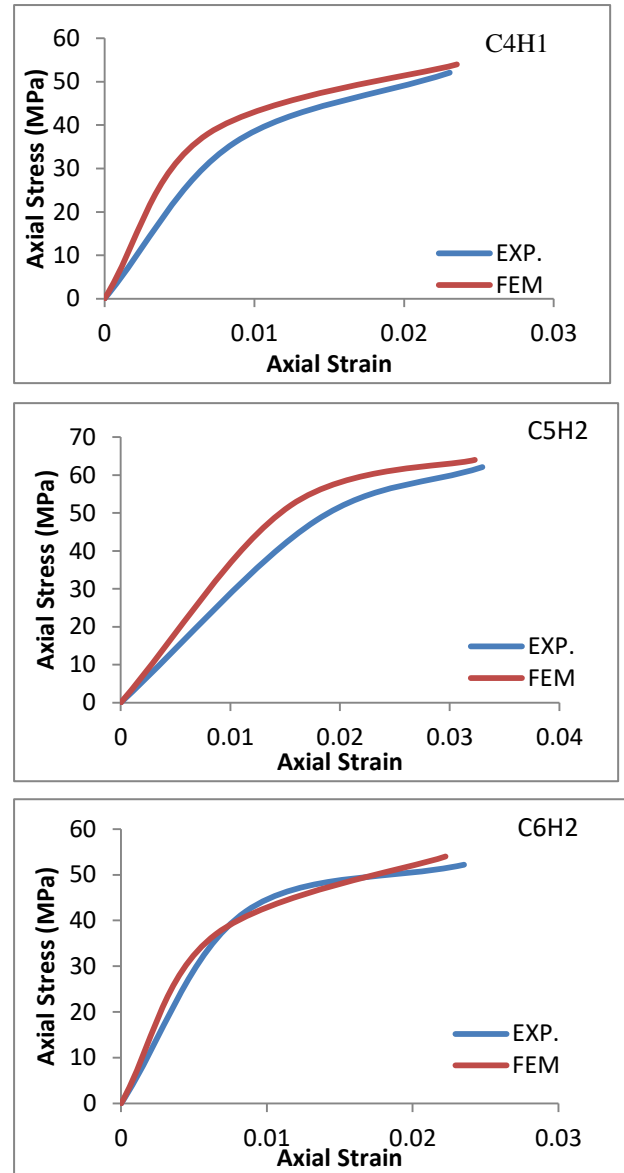
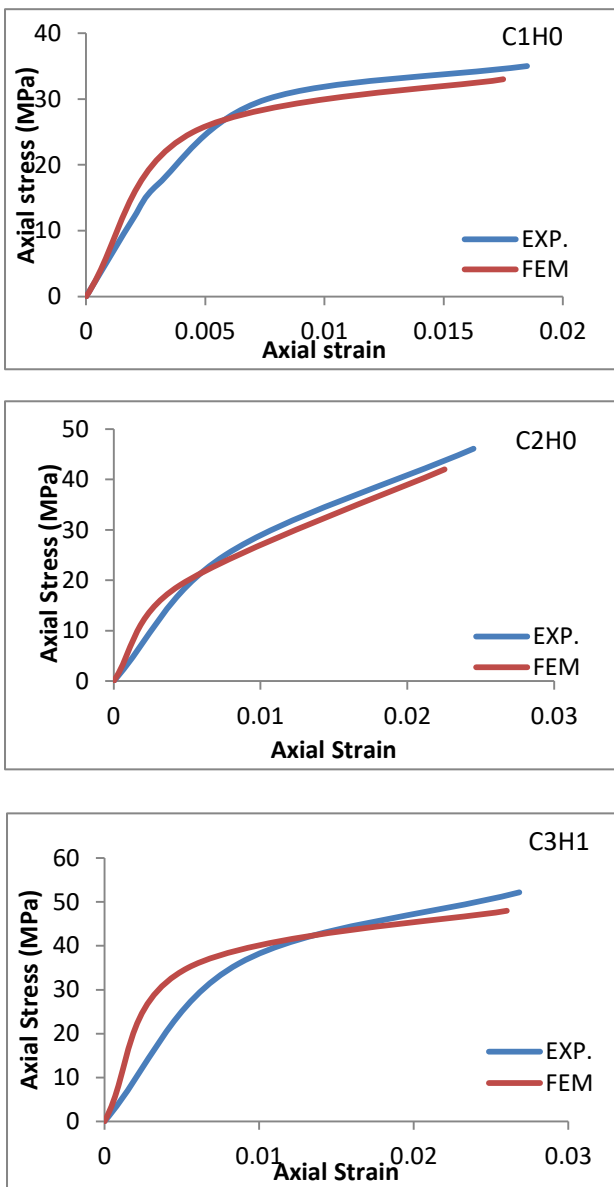

Figure 10. Experimental and numerical Stress-Strain curve for columns.

Table 3. Experimental and numerical results of ultimate load and axial strain

columns	Final load [KN]			Axial Strain		
	EXP.	FEM	FEM	EXP.	FEM	FEM
			EXP			EXP
C1H0	2557	2341	0.92	0.0185	0.01749	0.95
C2H0	1920	1864	0.97	0.0245	0.02253	0.92
C3H1	4850	4685	0.97	0.02683	0.02602	0.97
C4H1	2170	2263	1.04	0.02305	0.02353	1.02
C5H2	5776	5832	1.01	0.03298	0.03229	0.98
C6H2	2892	2922	1.01	0.02353	0.02226	0.95

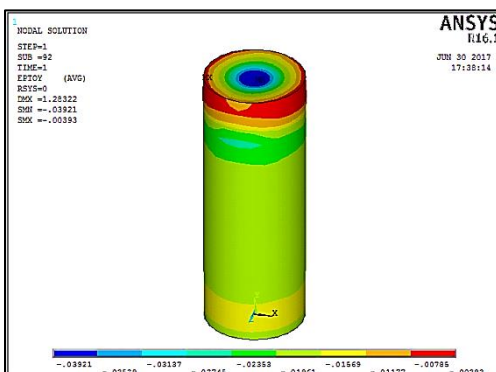
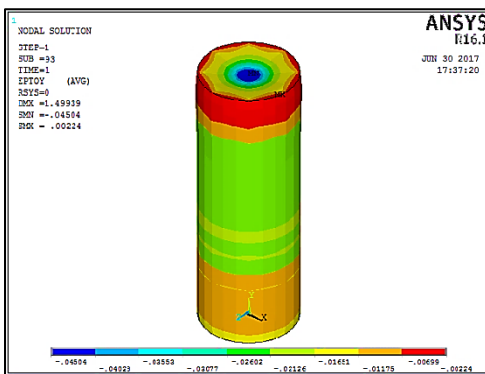
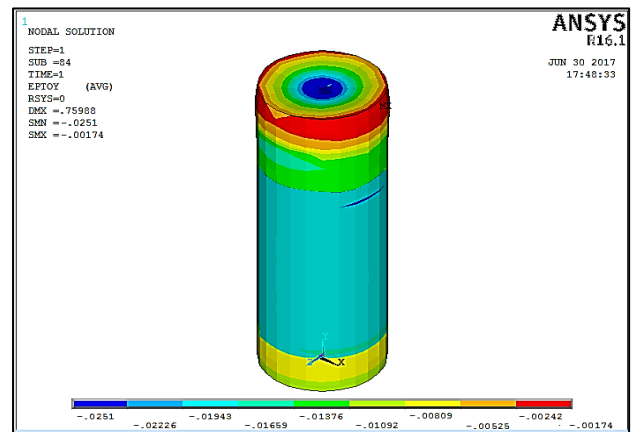
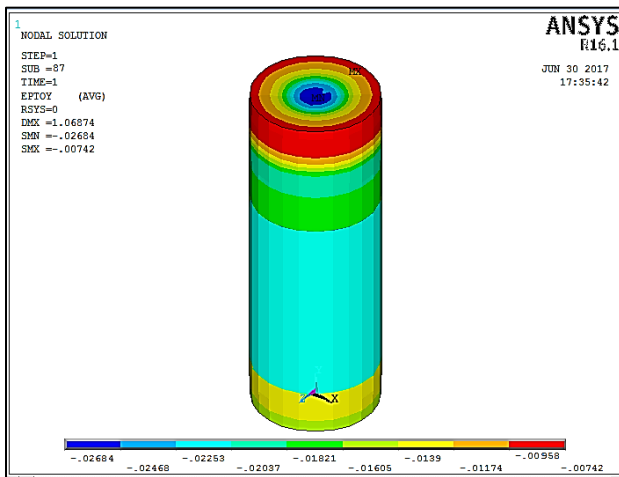
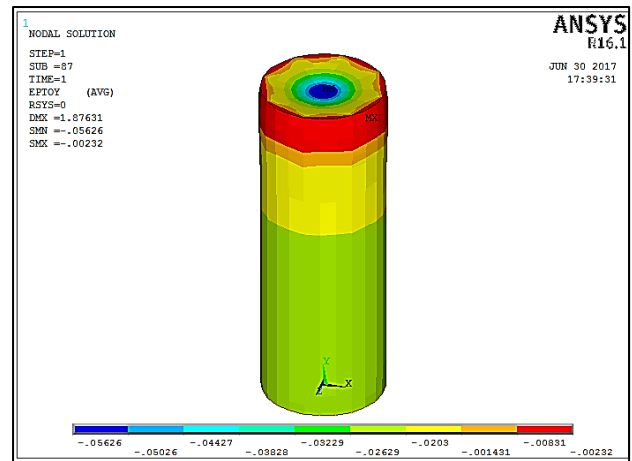
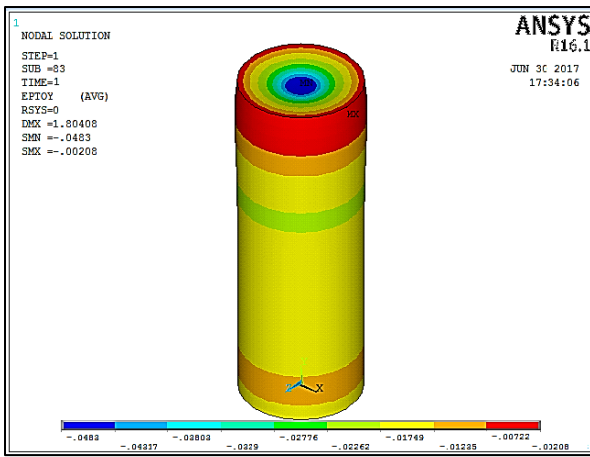

Figure 11. verification in axial strain for columns using ANSYS.

for most columns as explained above showing a stiffer response rather than the experimental results, that because:

1. Finite element does not include the effect of micro cracks produced in the concrete by drying shrinkage and handling; these would reduce the stiffness of the actual column.
2. Assumption that the concrete is a homogenous material in finite element analysis is not completely true , in fact, it is a heterogeneous material.
3. A full bond between steel and concrete is assumed in the F.E. analysis. However, the assumption would not be true in the actual column. As the bond slips occur, the composite action between the concrete and steel reinforcing was lost.
4. Inaccessibility to actual stress-strain curve of concrete was affected on stiffness of columns in numerical modeling.
5. Accurate modeling of supports condition leads to more precise results.
6. Plastic behavior of concrete, steel and CFRP bar were all checked at certain Gauss Points only and this may give overestimation results

This explains the degree of activity of the finite element model adopted in the present study.



## PARAMETRIC STUDY

parametric study is conducted to investigate the effect of most important parameters on a number of concrete columns strengthened with CFRP which were analyzed by the nonlinear finite element analysis previously . These parameters include: compressive strength of concrete, modulus of elasticity of CFRP and fiber orientation of CFRP composites.

### 1. Effect of Columns' Compressive Strength:

To study the effect of Columns' Compressive Strength on the behavior of circular reinforced concrete columns strengthened with CFRP, column was selected (circular C3H1 [Wang et al.2011]).Different concrete compressive strengths for circular column were considered. The specimen was confined with two layer of CFRP composites ( $t_f=0.167$  mm) .

Three values of concrete compressive strength ( $f'_c$ ) were used (35,50 and 80MPa) in addition to the original concrete compressive strength of experimental test (24.5 MPa for circular C3H1).

Fig.(12) reveals that in state of columns which have not been strengthened with CFRP wraps (controls), as concrete compressive strength is increased with values (35 , 50 and 80), the axial strength of columns increases with percentages (83.33, 136.11, 211.11%) and the ductility decreases with percentages (3.57, 7.143 and 21.43%) , as compared with the original state ( $f'_c= 24.5$ MPa ). The slight decrease in ductility for circular columns may belong to the inherent property of higher ductility of circular section and density of transverse steel.

On the other hand, for circular columns strengthened with CFRP wraps, as concrete compressive strength increases with the same values above the gain in axial strength is lower with percentages (177.78, 133.33, 125.88 and 121.43% ) and the gain in ductility is also lower with percentages (207.14, 181.5, 161.54 and 154.55 %), as compared with the controls respectively. It may be concluded from the above results that the increase of  $f'_c$  for circular columns without strengthening, results in equal increase in strength but different decrease in ductility. On the other hand the increases in axial strength and ductility which come from strengthening with CFRP jackets for circular columns reduces with the increase in concrete compressive strength, but the gain remains effective to enhance the compressive strength and ductility.

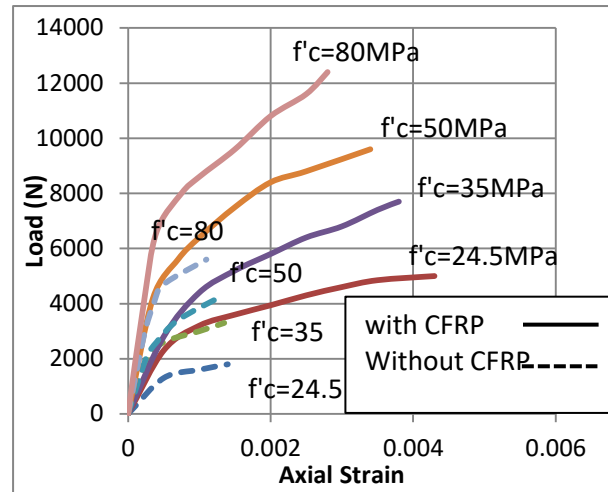

Figure 12. load-axial strain curves using finite element method for various  $f'_c$  for circular columns (circular C3H2) with and without CFRP wraps.

### 2. Effect of Modulus of Elasticity of CFRP:

To investigate the influence of the modulus of elasticity of CFRP composites, the same column used in the previous parametric studies were used here. Three values of modulus of elasticity (340,450and 560 GPa) were selected from (ACI committee 440.22R-02) in addition to the original value (240 GPa).

Fig. (13) reveals that as modulus of elasticity increases with values (340, 450 and 560GPa), the gained strength and ductility increase to be (29.79, 85.714, 125, 142.86%) and (43.75 ,62.5, 75, 131.25%) respectively, as compared with controls(without CFRP).

From the above results, it may be concluded that the modulus of elasticity is an important parameter in strengthening circular and square RC columns, and the increase in modulus of elasticity in high levels enhances the ductility significantly.

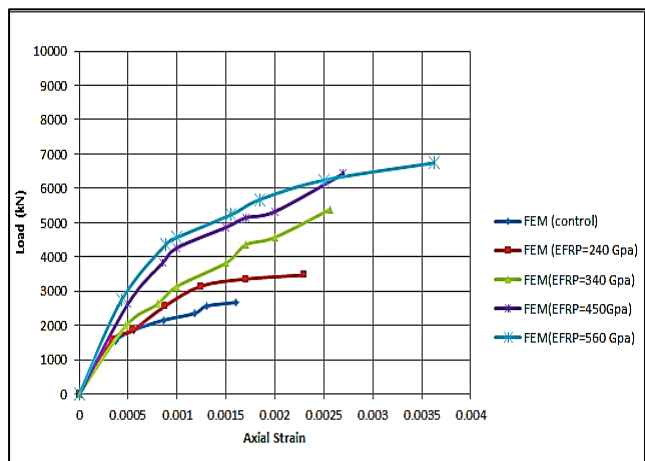

Figure 13. load-axial strain curves using FEM for various values of modulus of elasticity of column (circular C3H2)

### 3. Effect of wrap orientation of CFRP:

In an attempt to explain the influence of the fiber orientation on number of cylindrical specimens, circular columns with 150mm in diameter and 300 mm height were analyzed , the main parameters that have been investigated were: Wrap thicknesses with 1, 2, 3, and 4 layers (thickness of CFRP layer is 0.167mm), fiber orientation of  $0^\circ$ ,  $90^\circ$ ,  $\pm 45^\circ$  and combinations of them as explained in Table(4) and fig.(14).

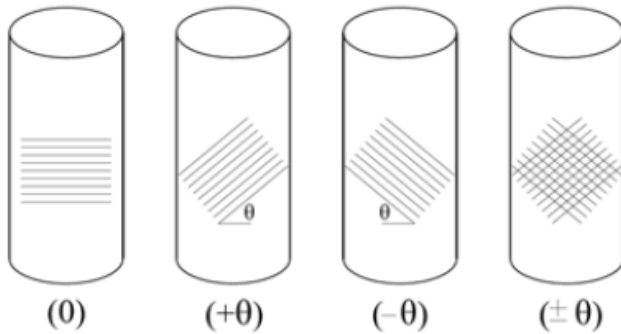

Figure 14. Fiber orientation in CFRP-wrapped cylinders.

Table 4. Specimens' layout

Specimens	Number of layers	Fiber orientation
P	--	Plain
T	1	$0^\circ$
TT	2	$0^\circ/0^\circ$
TTT	3	$0^\circ/0^\circ/0^\circ$
TTTT	4	$0^\circ/0^\circ/0^\circ/0^\circ*$
L	1	$90^\circ$
LL	2	$90^\circ/90^\circ$
LLL	3	$90^\circ/90^\circ/90^\circ$
TL	2	$0^\circ/90^\circ$
LT	2	$90^\circ/0^\circ$
LLT	3	$90^\circ/90^\circ/0^\circ$
DD'	2	$\pm 45^\circ$
DD'DD'	4	$\pm 45^\circ/\pm 45^\circ$
DD'T	3	$\pm 45^\circ/0^\circ$
TDD'	3	$0^\circ/\pm 45^\circ$
LDD'	3	$90^\circ/\pm 45^\circ$
DD'TT	4	$\pm 45^\circ/0^\circ/0^\circ$
TDD'T	4	$0^\circ/\pm 45^\circ/0^\circ$
LTDD'	4	$90^\circ/0^\circ/\pm 45^\circ$

\* direction of first/second/third/forth layer

Significant enhancement of strength and ductility of CFRP confined concrete was achieved. There is three distinct zones observed in stress-strain response of CFRP confined concrete. The first zone

is approximately linear and the second zone is nonlinear as a transition zone. The third zone depends on the wrap behavior. The third zone will have constant slope if the wrap has a linear behavior, and it will have a decreasing slope if the wrap has a nonlinear behavior. The specimens wrapped with hoop orientation have a bilinear behavior with a nonlinear transition zone. When the angle of fibers is changed to  $\pm 45^\circ$ , the behavior is accompanied by a larger flat region as a plastic deformation prior to failure. This behavior can be very useful in damping against seismic loading. The combination of hoop and angle orientation is not useful since the angle layers can't produce plastic deformations. At the end, an analytical model for ultimate stress and strain of confined concrete has been proposed as follow:

#### 3.1 Plain Specimen (control)

Fig. (15) shows the axial stress-strain curves for the plain specimen (without CFRP). The unconfined concrete strength was 36 MPa and corresponding strain of 0.22 percent.

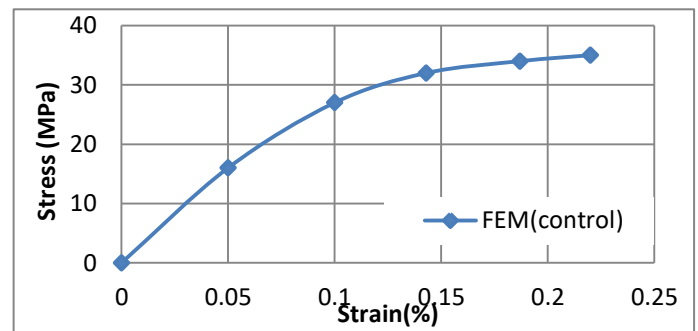

Figure 15. Stress-strain behavior of plain specimen (Without CFRP).

#### 3.2 Orientation with Transverse direction( $0^\circ$ )

Fig.(16) illustrated the typical axial stress-strain curve of wrapped specimen with one layer of transverse orientation (T) along by the axial stress-strain curve of plain specimen. in This figure shows that the confined concrete strength is increased from about 36 MPa to 72 MPa and ultimate strain of confined concrete is increased from about 0.22% to 0.6%.

While fig. (17) shows axial stress-strain response of wrapped specimens with 1, 2, 3, and 4 CFRP wraps with transverse(hoop)orientations(T, TT,TTT, and TTTT). This figure shows that for two layers confined specimen, concrete strength is 90.14 MPa; the ultimate strain is 0.92%, with three layers the confined concrete strength is 120MPa; the ultimate strain is 1.54%, and finally the with four

layers confined concrete strength is 142 MPa; with ultimate strain of 1.68%.

For every specimen, the stress-strain behavior of the confined specimen can be defined in three zones. In the first zone, the behavior of confined concrete is mostly linear and similar to unconfined (control) concrete. In second zone, the wrap is activated due to increase in lateral strain. So proportionate with the lateral strain, the wrap is stretched and a hoop tension stress is produced in circumference of specimen. This action produces a confinement stress on concrete core. In third zone, the wrap becomes fully activated due to large lateral strain therefore, confinement stress increases in proportion to the hoop stiffness of wrap. The first and third zones are consider to be approximately linear and the second zone as a transition zone is nonlinear.

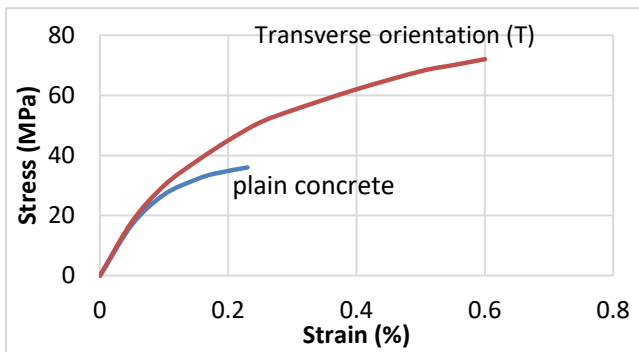

Figure 16. Behavior of one layer wrapped specimen in hoop direction.

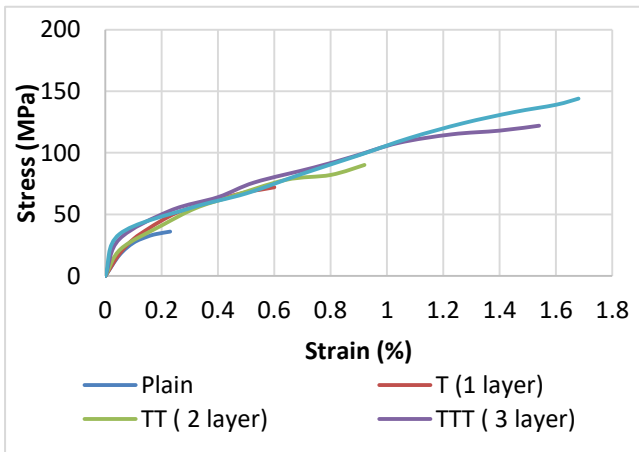

Figure 17. Behavior of wrapped specimens with hoop orientations.

### 3.3 Orientation with Longitudinal direction(90°)

Fig. (18) presented the axial stress-strain curves for wrapped specimens with 1, 2, and 3 layers of pure longitudinal orientations (L, LL, and LLL) along by the plain specimen. This figure shows that wrapping with pure longitudinal orientations will

not produce a significant improvement on strength and ductility of the specimens under uniaxial compression. Pure longitudinal orientation has a negligible effect on performance of stress-strain curve of circular columns due to little lateral support of fibers and it's buckling under uniaxial compression. Results of specimens wrapped with combination of transverse and longitudinal orientations (LT, TL, and LLT) are presented in fig. (19). It is shown the similarity between behavior of specimens with combined orientations with those of transverse orientation. fibers in the transverse orientation were the controller in the strength, ductility, and stiffness of wrapped specimens with combination of transverse and longitudinal orientations.

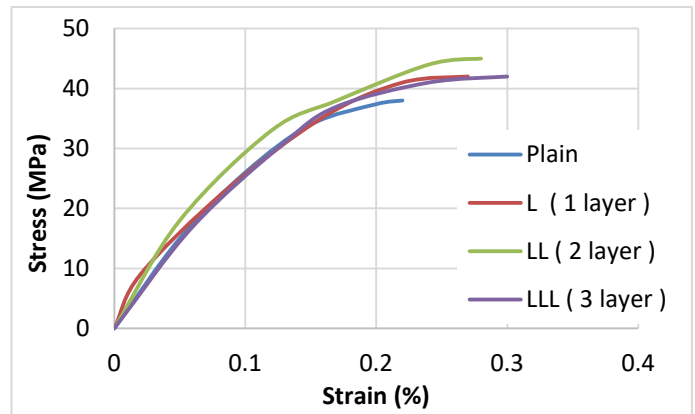

Figure 18. Behavior of specimens with longitudinal orientations.

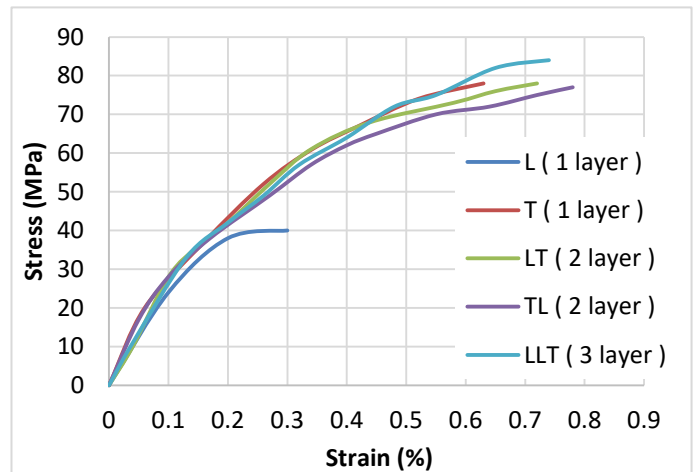

Figure 19. Specimens with combination of transverse and longitudinal orientations.

### 3.4 Orientation with ±45° angle

Fig. (20) illustrated the behaviors of wrapped specimens with angle orientations DD' and DD'DD'. This figure shows the essential influence of the angle orientation of fibers on the stiffness of the specimens.

A bilinear behavior with a positive slope is the stress-strain curve of wrapped specimens with hoop

fibers orientation; however, when the angle of fibers is changed to  $\pm 45^\circ$ , the behavior is accompanied by a larger flat region prior to failure. This behavior can be very useful in damping against seismic loading. In the angle orientation with four layers DD'DD', ultimate stress and strain are about 76 MPa and 2.10%, respectively. In two layers angle orientation DD', ultimate stress and strain are about 63.0 MPa and 0.76%, respectively, So the influence of angle orientations on enhancement of ductility and energy dissipation is significant.

The stress-strain behavior of wrapped specimens with combination of angle and transverse orientations are presented in fig. (21) shows . It is shown a comparison between two specimens with TDD' and DD'T orientations along by DD' and TTT orientations. The overall behavior of TDD' and DD'T orientations is similar to pure transverse orientations, not to pure angle orientations. These two specimens have a bilinear behavior with a lower second slope, and the failure is controlled by the hoop layer. The DD'T orientation on the average has a lower second slope than the TDD' orientations, due to shear lag, the inner layers are activated sooner than the outer layers.

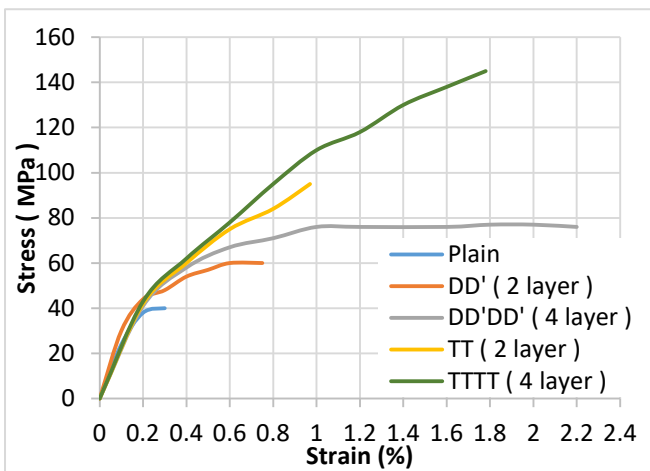

Figure 20. Behavior of wrapped specimens with angle orientation.

Fig. (22) studied the combination of angle and longitudinal orientation. It is shown an elastic perfect plastic behavior for LDD' specimen and it is similar to DD' orientation, so there were no effects of longitudinal layers on the stress-strain behavior. 1.25% are the ultimate strains of these specimens.

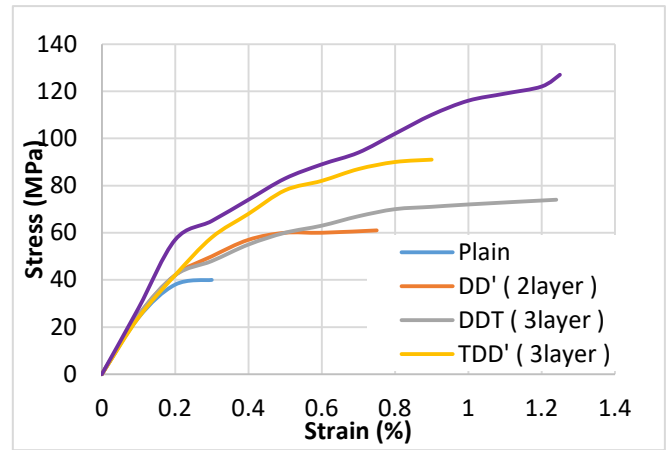

Figure 21. Specimens with combination of angle and transverse orientation.

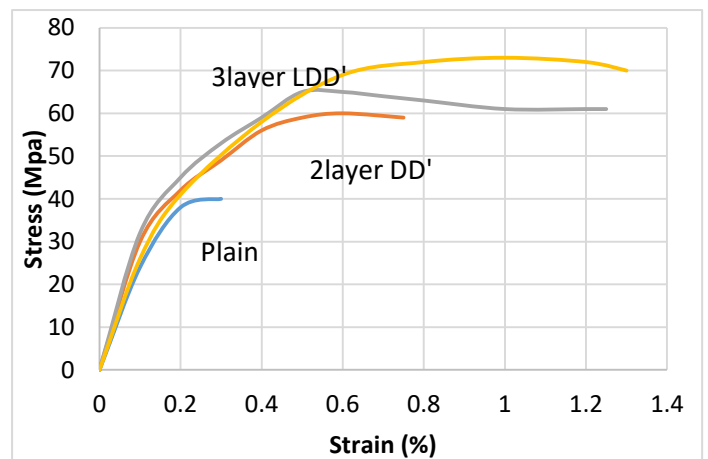

Figure 22. Combination of angle and longitudinal orientation.

It is noted that the compressive strength of the wrapped concrete cylinders also depends on the thickness of FRP wraps. So it is suggested that for FRP wrapped concrete cylinder design the FRP must have sufficient wall thickness. Otherwise, the structural behavior is not ideal and the strengthening effect cannot be fully realized.

## CONCLUSIONS

Depending on the results of the nonlinear finite element analysis on the CFRP-strengthened reinforced concrete columns conducted throughout this study, the following conclusions can be made:

1. The general behavior of finite element stress-strain curves at mid height of the columns strengthened with CFRP jacket using ANSYS program shows good agreement with the available experimental stress-strain curves, and the analytical results have good convergence with the

experimental results Therefore, the finite element models used in this study are suitable in analysis of this type of structure.

2. The strengthening, provided by the CFRP jacket system, improves both the load carrying capacity and the ductility of the reinforced concrete columns and this method of strengthening is seen to be applicable to different kinds of columns (circular, square and rectangular),but in different degrees.

3. The gain in strength and ductility for RC columns strengthened with CFRP decreases with the increase in concrete compressive strength ( $f_c$ ). For a circular column, when  $f_c$  is increased from (24.5 to 80 MPa), the gained increase in strength decreases from (177.78 to 121.43%) and the ductility decreases from (207.14 to 154.55%), as compared with the controls respectively.

4. Low-strength concrete specimens confined with CFRP produced higher result in terms of strength and strains than for high-strength concrete similar specimens. Therefore, with increasing concrete strength, the effect of CFRP confinement on the bearing deformation capacities will decrease.

5. The modulus of elasticity of CFRP is less effective in increasing the strength, but it is more effective in increasing the ductility. For the circular columns, the increase in modulus of elasticity from (240 to 560GPa) results in an increase in gained strength (29.79 to 142.86%) and gained ductility (43.75 to 131.25%), as compared with the controls respectively.

6. The CFRP confinement effect cannot be fully realized without proper fiber orientation and sufficient wall thickness.

## REFERENCES

1. ACI Committee. Copyright 2011. Building Code Requirements for Structural Concrete (ACI 318-11): American Concrete Institute.
2. Al-Rousan, Rajai Z., and Mohsen A. Issa. "Stress-strain model and design guidelines for CFRP-confined circular reinforced concrete columns." *Polymer Composites* (2016).
3. ANSYS. 2016. ANSYS Help. Release 16.0.
4. Cole, C., Belarbi, A., "Confinement Characteristics of Rectangular FRP-jacketed RC Columns", Proceedings of the Fifth International Symposium on Fiber Reinforced Polymer for Reinforced Concrete Structures, Cambridge , UK, July 16-18 ,2001,pp. 823-832.
5. Kabashi, N., C. Krasniqi, and V. Nushi. "Analysis and Behaviour the Concrete Columns Strengthening with the Carbon Polymer Fibres." *Civil Engineering and Architecture* 2.9 (2014): 317-322.
6. Li, Guoqiang, et al. "Effect of fiber orientation on the structural behavior of FRP wrapped concrete cylinders." *Composite structures* 74.4 (2006): 475-483.
7. Mander, John B., Michael JN Priestley, and R. Park. "Theoretical stress-strain model for confined concrete." *Journal of structural engineering* 114.8 (1988): 1804-1826.
8. Moaveni, Saeed. *Finite Element Analysis Theory and Application with ANSYS*, 3/e. Pearson Education India, 2008.
9. Parvin A, Jamwal AS. Effects of wrap thickness and ply configuration on composite-confined concrete cylinders. *Compos Struct* 2005;67(4):437-42.
10. Parvin, Azadeh, and Aditya S. Jamwal. "Performance of externally FRP reinforced columns for changes in angle and thickness of the wrap and concrete strength." *Composite Structures* 73.4 (2006): 451-457.
11. Rochette P, Labossiere P. Axial testing of rectangular column models confined with composites. *J Compos Constr ASCE* 2000;4(3):129-36
12. Swanson Analysis Systems, Inc."ANSYS User's Manual", Canonsburg, Pa, 2012.
13. Saadatmanesh H., Ehsani M.R, Li M.W. (1994); Strength and Ductility of Concrete Columns Externally Reinforced with Fiber Composites Strips, *ACI Structural Journal*, Vol.91(4), 1994, pp. 434 – 447.
14. Sadeghian P, Rahai AR, Ehsani MR. Numerical modeling of concrete cylinders confined with CFRP composites. *J Reinforced Plastics Compos SAGE* 2007;(in press)
15. Shirmohammadi, Fatemeh, Asad Esmaeily, and Zohreh Kiaeipour. "Stress-strain model for circular concrete columns confined by FRP and conventional lateral steel." *Engineering Structures* 84 (2015): 395-405.
16. Wang, Zhen Yu, Dai Yu Wang, and Da Gang Lu. "Behavior of Large-Scale Circular and Square RC Columns Confined with Carbon Fiber-Reinforced Polymer under Uniaxial Compression." *Advanced Materials Research*. Vol. 163. Trans Tech Publications, 2011.