

STRUCTURAL BEHAVIOR OF SELF COMPACTING CONCRETE

Jamal Abdul-Samad Khudair^a, Aqeel Hatem Chkheiwera^a

^aCivil Engineering Department, Engineering College, Basrah University, Iraq

ARTICLE INFO

Received: 17/5/2015

Accepted: 26/8/2015

Keywords

self-compacting concrete, structural behavior, flexure, shear, punching shear

ABSTRACT

This study investigated the influence of type of concrete (self compacting concrete (SCC) and normal concrete (NC)) and compressive strength (30, 50 and 62 MPa) on the flexural and shear behavior of reinforced concrete beams, as well as punching shear of slabs. To achieve these targets, 18 beams and 6 slabs are equipped, tested and assessed. The tested beams were divided into three groups, the first group consists of six beams failed in flexure, the second group contains six beams without web reinforcement failed in shear with shear span/depth ratios of 3 (slender beams), the third group consists of six beams without web reinforcement failed in shear with shear span/depth ratio of 1 (deep beams), each group consisted of three SCC and three NC geometrically similar rectangular beams of different concrete strengths. Test results indicated that, for beams failing in flexure, SCC beams showed similar ultimate load to NC beams. For slender beams failing in shear, the ultimate load for beams with f_c' of about 32 and 48 MPa, NC beams showed 6.75 % higher ultimate load compared with SCC beams, but beams with f_c' of about 62 MPa, SCC and NC beams showed almost the same ultimate load value. For deep beams, no considerable difference in ultimate loads for SCC and NC beams was noticed. For the six geometrically similar slabs (three slabs made with SCC and three slabs made with NC of different concrete strengths) which were designed to fail in punching shear, it was found that, SCC slabs exhibited 17.25 % higher ultimate punching shear load than NC slabs.

التصرف الإنشائي للخرسانة ذاتية الرص

الكلمات المفتاحية

الخرسانة ذاتية الرص، التصرف الإنشائي، الانثناء، القص، القص الثاقب

الخلاصة

هذه الدراسة تحرت عن تأثير نوع الخرسانة (ذاتية الرص او اعتيادية) ومقاومة الانضغاط (30 و 50 و 62 نت/ملم²) على سلوك الانثناء والقص للعتبات الخرسانية المسلحة، فضلا عن القص الثاقب للبلاطات. ولتحقيق هذه الأهداف تم إعداد و فحص و تقييم 18 عتبة وستة بلاطات. قسمت العتبات المفحوصة إلى ثلاث مجموعات، المجموعة الأولى تتكون من ستة عتبات تفشل بالانثناء، المجموعة الثانية تحتوي على ستة عتبات بدون حديد تسليح للقص تفشل بالقص مع نسبة فضاء القص / العمق الفعال تساوي 3 (عتبات نحيفة)، المجموعة الثالثة تتكون من ستة عتبات بدون حديد تسليح للقص تفشل بالقص مع نسبة فضاء القص / العمق الفعال تساوي 1 (عتبات عميقة). كل مجموعة من هذه المجموعات تتكون من ثلاث عتبات مصنوعة من خرسانة ذاتية الرص وثلاث مصنوعة من خرسانة اعتيادية متشابهة من حيث الشكل الهندسي ومختلفة بمقاومة الانضغاط. أظهرت النتائج انه بالنسبة للعتبات التي فشلت بالانثناء، عتبات الخرسانة ذاتية الرص أعطت حمل أقصى مشابه لعتبات الخرسانة الاعتيادية. أما بالنسبة للعتبات النحيفة التي فشلت بالقص ذات مقاومة انضغاط تقريبا 32 و 48 نت/ملم² فان عتبات الخرسانة الاعتيادية أعطت حمل أقصى أعلى ب 6.75 % بالمقارنة مع عتبات الخرسانة ذاتية الرص، بينما العتبات ذات مقاومة انضغاط 62 نت/ملم²، فكل النوعين من العتبات أعطت تقريبا نفس الحمل الأقصى. أما بالنسبة للحمل الأقصى للعتبات العميقة، فلم يلاحظ فرق مهم بين عتبات الخرسانة الاعتيادية وعتبات الخرسانة ذاتية الرص. أما بالنسبة للبلاطات الست (ثلاثة مصنوعة من خرسانة ذاتية الرص وثلاثة مصنوعة من خرسانة اعتيادية) وهي متماثلة هندسيا لكنها مختلفة بمقاومة الانضغاط للخرسانة) والمصممة لكي تفشل بالقص الثاقب، فقد وجد بان البلاطات المصنوعة من خرسانة ذاتية الرص تبدي حمل أقصى للقص الثاقب اكبر ب 17.25 % من البلاطات المصنوعة من الخرسانة الاعتيادية.

Introduction

Overcrowded arrangement of rebars in reinforced concrete (RC) members, such as columns and beams, makes it difficult to compact concrete properly with the use of a mechanical vibrator. Unfilled voids and macro-pores inside concrete stemming from improper vibration and compaction may affect the mechanical strength and durability of the concrete and are among potential causes of deterioration in concrete [1]. Self-compacting concrete can be used to facilitate the construction of elements without mitigating structural performance and durability. Most studies on SCC deal with mixture proportioning and characterization of fresh- and hardened- concrete properties with limited information on structural performance. One of the barriers to the widespread acceptance of SCC is the lack of information regarding structural properties of sections cast with SCC. Although widespread application of SCC is still restricted by a lack of manuals and codes, it is expected that SCC will gain more popularity globally as a cost saving option. There have been a number of notable studies on structural behavior and performance of RC structures made with SCC..

Sonebi et al. (2003) [2] showed that the mode of failure and load deflection response of the beams cast with SCC and normal concrete were similar. For concrete having 60 MPa compressive strength, it was observed that the ultimate moment capacity of the SCC beam was comparable with the NC beam and the maximum deflection of the SCC beam was slightly higher than that of the reference beam.

The studies of **Schiessl and Zilch(2001)**[3] on the contribution of aggregate interlock to the shear strength of cracked sections considered the shear strength of the interface between prefabricated surfaces under varying levels of normal stress. It was found that for similar concrete strength, the shear strength for any given normal stress was about 10% lower in case of SCC due to smoother crack surfaces.

Hassan (2012) [4] studied the effect of shear span to effective depth ratio, amount and arrangements of web reinforcement on the shear strength of SCC deep beams. It was found that, as the shear span to effective depth ratio decreased from 1.2 to 0.8, the percentage of increase in the failure load was about 32.5 %.The percentage of increase in the failure load were 42.6%,27.7%,19.1%, as both horizontal and vertical, horizontal only and vertical only web reinforcement ratios increased from 0% to 0.168%.

Up to date, a number of researches on structural behavior and performance of RC structures made with SCC was carried out. However, there is limited number of experimental and theoretical studies on the structural behavior reinforced beams and slabs made with SCC.

Research significance

In the present study, the test results of 24 specimens are presented and the effects of the variation in f_c' (30, 50 and 62 MPa) on the structural behavior of SCC and NC beams and slabs are discussed, test results for reinforced SCC and NC were compared. An evaluation of the efficiency of the existing design equations for SCC beams and slabs was performed. The recommendations of this paper can be of special interest to designers considering the use of SCC in structural applications.

Experimental program

Description of specimens

To study the structural behavior of reinforced SCC and compare it with that of reinforced NC, four groups of specimens were prepared and tested:

- 1- 6 Beams designed to fail in flexure.
- 2- 6 Beams designed to fail in shear with $(a/d = 3)$ as a slender beams.
- 3- 6 Beams designed to fail in shear with $(a/d = 1)$ as a deep beams.
- 4- 6 Slabs designed to fail in punching shear.

Each group (six specimens) was made with two types of concrete mixes, three by using self-compacting concrete (type SCC), and the other by using normal concrete (type NC). For each type of concrete, three different mix proportions were used to give three values of compressive strength (f_c'), about 30, 50 and 62 MPa, in identical specimens.

Figures (1) to (4) show specimens' details. All beams had width (b) of 150mm and total depth (h) 300 mm, effective depth (d) of 268mm and a cover of 20mm. two flexural reinforcement ratios were used for beams; 1% ($2\Phi 16$ mm) for beams designed to fail in flexure and 2% ($3\Phi 16$ mm) for beams designed to fail in shear (slender and deep beams). the shear reinforcement ($\Phi 10$ mm @130mm) was use only in beams designed to fail in flexure to ensure bending failure, while the rest of beams were without web reinforcement to ensure shear rather than bending failure. The beams were simply supported and loaded with two points (300mm) a part at midspan, the distance between the supports was varied to produce the desired a/d ratio.

All the slabs were 800*800*95 mm with effective depth of 65mm and flexure reinforcement ratio of 1.1% in two directions to ensure punching shear failure. Slabs were simply supported and loaded with steel column (75*75mm) at the center of slab, the distance between the supports were 700mm.

The specimen designation included a combination of letters and numbers, SCC or NC indicate the type of concrete; 30, 50 or 60 indicate the compressive strength of concrete; and F,S and D to designate the type of beams failure.

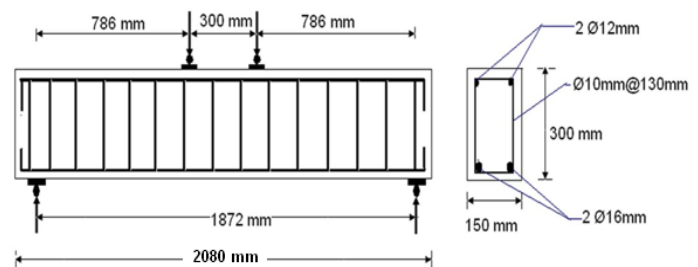

Figure (1) - Details of the tested beams failing in flexure.

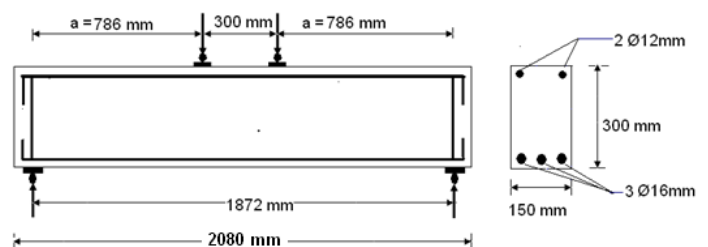

Figure (2)-Details of the beams failing in shear with $(a/d=3)$

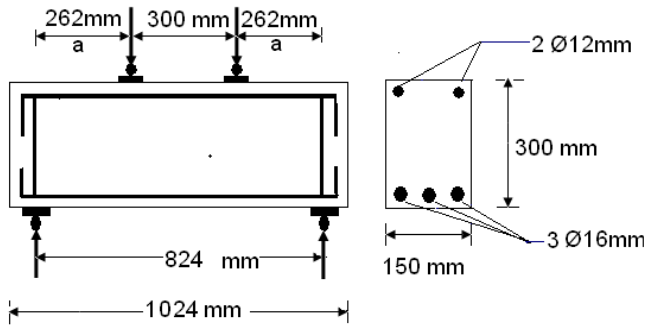

Figure (3)- Details of the beams failing in shear with(a/d=1)

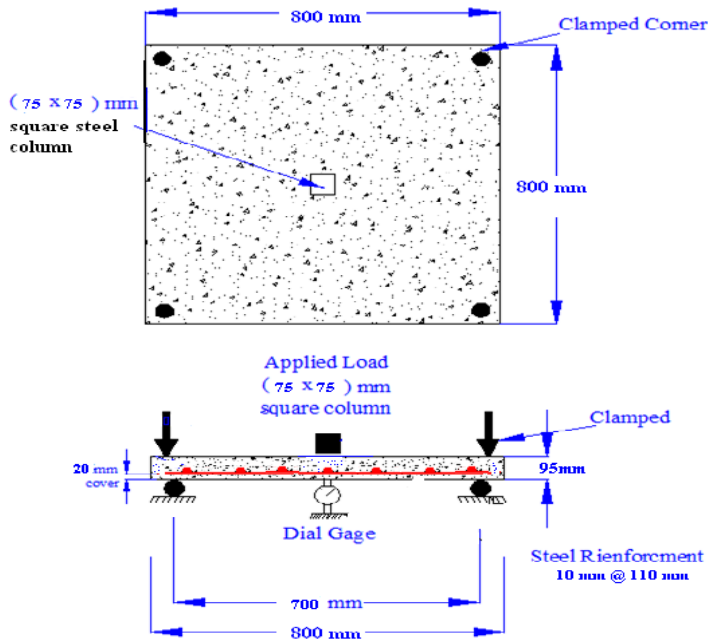

Figure (4) - Details of the slab specimen.

Materials, mix proportions and properties of concrete

Ordinary Portland cement with specific gravity of 3.15 and Blaine fineness 3120 cm²/g was used. Grinded limestone which has been brought from local market is used; this material is locally named as "Al-Gubra". It was screened in order to get powder by using sieve 0.125 mm. Specific surface of the limestone powder used was 3100cm²/g. Specific gravity of the limestone powder was 2.69. A local natural coarse and fine aggregate from Zubair ,Basrah ,that meet the requirement of Iraqi standard no 45 -1984[5] were used. The coarse and fine aggregate each had a specific gravity of 2.65, water absorption of 0.65 and 1.1% respectively. High efficiency acrylic copolymer-based superplasticizer as per ASTM C494 –type A, D and G specification[6] having a specific gravity of 1.08 and a total solid content of 40% was used. Ordinary tap water is used without any additives for mixing, casting and curing. The deformed bars had average yield strength of 480 MPa and an average tensile strength of 725 MPa.

Concrete mixes (SCC and NC) were designed to give three levels of compressive strength (30,50 and 62 MPa),that is to study the effect of compressive strength on the structural behavior of reinforced SCC and NC for beams and slabs. The water-cement ratio of each compressive strength level was kept

constant for both SCC and NC mixes in order to achieve similar compressive strength as shown in Table (1).

Table (2) and (3) present the fresh and hardened properties of NC and SCC mixtures. The traditional slump test according to ASTM C 143 [7] was conducted for NC. The slump flow test was conducted to evaluate the viscosity and flowability of SCC mixture while V-funnel and L-box tests were conducted to evaluate the stability and the passing ability respectively, all these testes were carried out as per EFNARC (2005)[8] . The (300*150mm) cylinders were used to determine the compressive strength (fc'), the indirect tensile (ft) strength and modulus of elasticity(Ec) as per ASTM C 39 [9] , ASTM C 496 [10] and ASTM C 469 [11] respectively, as well as 150mm cubes were used to determine the compressive strength(fcu) and (100*100*500 mm) prisms to determine modulus of rupture as per B.S1181-116 [12] and ASTM C 78 [13] respectively, for both NC and SCC mixtures.

Preparation of Specimens

The six concrete mixtures used in this investigation were cast in Construction Materials Lab of Engineering College – Basrah University. Immediately after concrete completely mixed, tests on fresh properties of the concrete mixtures as well as casting of beams and slabs in prepared wooden forms were carried out. SCC beams were cast without consolidation – the concrete was poured in the formwork from one side until it flow and reached the other side. Visual observation showed that the SCC properly filled the forms with ease of movement around reinforcing bars in each reinforcement configuration. On the other hand, NC beams were consolidated using electrical vibrators and trowel finished for smooth top surfaces. The placement of NC beams was labor intensive and the time required to cast and finish each specimen was much longer than that required for SCC beams. Formworks were removed after 24 h of casting and the specimens were moist cured for seven days and then air cured until the date of testing. The cubes, prisms and cylinders (to determine compressive strength, modulus of rupture, splitting strength and modulus of elasticity) were cast and cured under the same conditions of casting and curing of corresponded beams and slabs.

Test set up, instrumentation and loading procedure

The beam specimens were tested as simply supported beams under two-point loads at mid span (Figs. 1,2 and 3),while the slab specimens were tested as four simply supported edges under concentrated load in center of slab by steel column (75*75 mm) as shown in Fig.(4). The test setup included the use of a hydraulic machine (2000 kN capacity) that applied load gradually on the mid-span of beam specimens and center of slab specimens until failure as shown in Figs.(5-a) and(5-b). The load was applied in a load control fashion in ten stages. Each stage corresponds to 10% of the expected failure load. The deflection at mid-span was measured by using dial gauges of 0.01 mm per division. The cracks were sketched and crack-width measured using a hand microscope of accuracy 0.02 mm per division.The tests also provided information on the overall behavior of beams including first cracking and ultimate loads, load-deflection response and development of cracks, crack patterns, crack width, load transfer mechanisms and failure modes. The final failure was carefully observed

Table (1)-Mix proportion of SCC and NC.

Concrete type	Mix symbol	Cement (kg/m ³)	LSP (kg/m ³)	Water (kg/m ³)	Sand (kg/m ³)	Gravel (kg/m ³)	SP/C %by wt.
SCC	SCC30	351	151	181	755	944	0.78
	SCC50	451	113	175	779	892	0.89
	SCC62	550	50	159	820	876	1.90
NC	NC30	350	0	181	700	1155	0
	NC50	450	0	175	675	1115	0.20
	NC62	550	0	159	660	1085	0.65

Table (2)- Properties of fresh SCC and NC.

Concrete type	Mix symbol	Slump flow (mm)	T 500 (sec)	V-funnel (sec)	BR	SI %	Slump mm
SCC	SCC30	7.5	2.20	8.05	0.75	7.5	-
	SCC50	7.1	2.75	8.75	0.91	6.5	-
	SCC62	659	3.60	11.70	0.93	5.0	-
NC	NC30	-	-	-	-	-	100
	NC50	-	-	-	-	-	100
	NC62	-	-	-	-	-	110

Table (3) - Properties of hardened SCC and NC at 28 days.

Concrete type	Mix symbol	Compressive strength(MPa)		fr (MPa)	ft (MPa)	Ec (GPa)
		Cube 150x150 fcu	Cylinder 150x300 f'c			
SCC	SCC30	39.1	32.8	5.33	3.78	32.113
	SCC50	54.8	47.4	6.63	4.50	34.364
	SCC62	70.0	62.7	7.60	5.70	36.115
NC	NC30	39.8	32.2	4.44	3.10	32.262
	NC50	56.2	48.1	5.61	3.83	35.125
	NC62	70.8	62.9	7.58	5.67	37.00

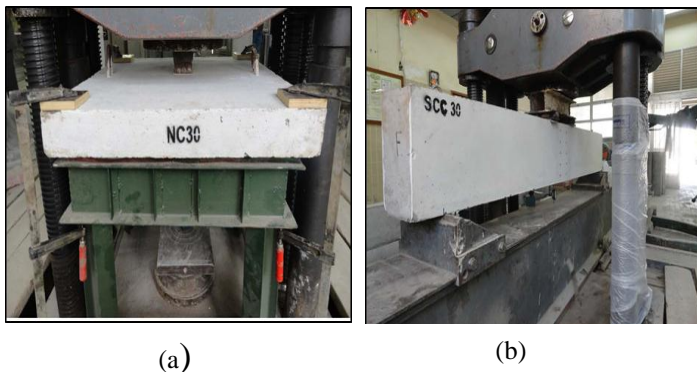

Figure (5)-Test setup of tested specimens (a) beams (b) slabs

Test Results Discussion

Tables (4) to (7) list the main test results from the observations during the tests, which included the first cracking load, ultimate load, and measured moment at ultimate load and deflection at service load for beams designed to fail in flexure. Figures (6) to (14) give examples for deflection, crack width, and crack pattern of some specimens.

Beams Designed to Fail in Flexure

All beams tested in this study were under-reinforced and failed by crushing of concrete after the tension reinforcement had yielded. The first visible flexural cracks were noticed at 21.3 to 25 % of failure load as demonstrated in Table (4). These cracks were vertical, started from the bottom outside of the beam

between the two point applied loads. As the load increased the cracks propagated diagonally towards the concentrated loads. At the upper end of some cracks, inclined cracks were formed and extended towards the applied loads. These cracks were formed in place out the region between the two applied loads. When the load reached a value that caused yielding of steel, the deflection was increased and cracks were propagated quickly, then the load was slightly increased so that the crushing of compression face of concrete under loads occurred. Summary of test results are presented in Table (4).

The cracking loads are presented in Table (4). For all tested beams, comparison is performed with first cracking load for SCC and NC beams. SCC beams showed about (12-14.5%) higher cracking loads than comparable NC beams. This may be attributed to that the modulus of rupture of self-compacting concrete is greater than that of conventional concrete. The first cracking load increases with the increase in compressive strength of concrete for both two types of concrete (SCC and NC) as shown in Table(4), the first cracking load of beams (SCC50F) and (SCC62F) is higher than that of beam (SCC30F) by 5% and 12.5% respectively. The first cracking load of beams (NC50F) and (NC62F) is greater than that of beam (NC30F) by 7.1% and 14.3% consecutive. This is due to that the tension strength of concrete increase with increasing the compressive strength.

For the ultimate load, SCC beams give almost the same ultimate load values as that of NC beams for a given concrete compressive strength. This means that there is no significant effect for change the type of concrete on the ultimate strength of flexural member.

From Table (4) it can be observed that the ultimate load increases with increasing f'_c for both two types of concrete, where beam (SCC50F) showed 5% higher ultimate load than beam (SCC30F), and beam (SCC62F) showed 15% higher ultimate load than beam (SCC30F). While the ultimate load of beams (NC50F) and (NC62F) was higher than that of beam (NC30F) by 4.9 % and 15.7% respectively.

Series SCC exhibited higher ratio of the first cracking load to ultimate load than beams made with NC as shown in Table (4). This is attributed to the higher first cracking load of SCC group.

The experimental ultimate moment strengths of the beams are shown in Table (1). It can be noticed that beams of group (SCC) give relatively same failure moment when compared with similar beams of group (NC). Therefore it can be concluded that the use of self-compacting concrete has no negative effect on ultimate flexural strength of the beams. The theoretical ultimate moment strength of the beams, which were calculated according to ACI 318M-11 Code [14], are illustrated in Table (1).

In the ACI code, the calculations are based on the equation:

$$M_n = A_s f_y d \{ 1 - 0.59 (f_y / f'_c) \rho \} \dots \dots \dots (1)$$

Table (4) also shows that, ACI code procedure underestimate the actual ultimate moment strength of the beams. The ratio of experimental to calculated ultimate moment of the beams ranged from (1.296) to (1.420) with average value of (1.347) and COV of (3.9%) for beams made with self-compacting concrete and ranged from (1.293) to (1.421) with average value of (1.341) and COV of (4.2 %) for NC beams.

From Fig. (6), it can be noticed that, beams of group (SCC) exhibit slightly more midspan deflection than similar beams of group (NC) at all loading stages. The increase in deflection for beams (SCC) is attributed to the lower modulus of elasticity of self-compacting concrete used in making these beams.

The deflection of both groups of beams SCC and NC decrease with increase of concrete compressive strength. This is attributed to that modulus of elasticity increases as a compressive strength increases. With the same applied load, the deflection decreased with increasing f'_c , this is because deflection is influenced by the beam stiffness. Thus increasing (EI/L) leads to smaller deflection. Table (4) shows the measured and calculated service load deflection at midspan of the beams. This service load is calculated by dividing the failure load by 1.6 (Considering that the applied load is the live load). The mid-span deflection of the beams at service load is calculated according to ACI 318-11 Code [14] method and the results are presented in Table (4). The procedure of predicting deflection in ACI Code is based on the elastic theory. The effective second moment of area is to be found from equation:

$$I_e = \left(\frac{M_{cr}}{M} \right)^3 I_g + \left[1 - \left(\frac{M_{cr}}{M} \right)^3 \right] I_{cr} \dots \dots \dots (2)$$

$$\Delta = K \left(\frac{M}{E_c * I_e} \right) L^2 \dots \dots \dots (3)$$

Where K is factor depend on type of loading and support condition.

With the comparison of SCC beams and NC beams, it can be seen that the number of cracks in the SCC beam were higher than those in the NC beam as shown in Fig.(7). Figure (8) presents crack width load relations, this Figure shows that NC beams have cracks width slightly greater than same SCC beams in the same load stage. This may be attributed to that the first crack load of SCC beams greater than that of NC beams. However, the crack width decreases as concrete

compressive strength increases in both types of concrete. This is attributed to the higher modulus of rupture and higher modulus of elasticity of higher strength concrete.

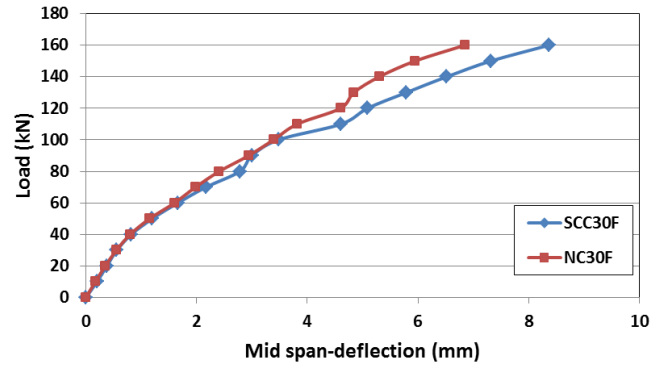
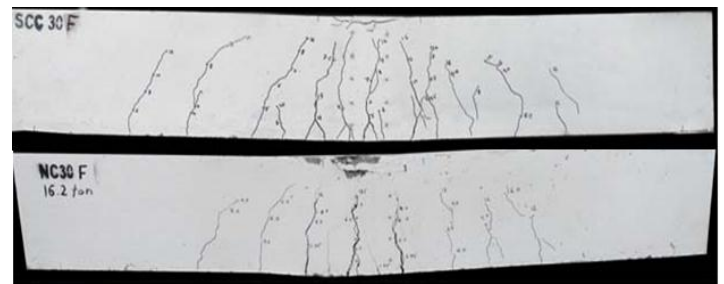

Figure (6) - Load - midspan deflection curves for SCC and NC beams failed in flexure



Figure(7)- Crack pattern of beams designed to fail in flexure

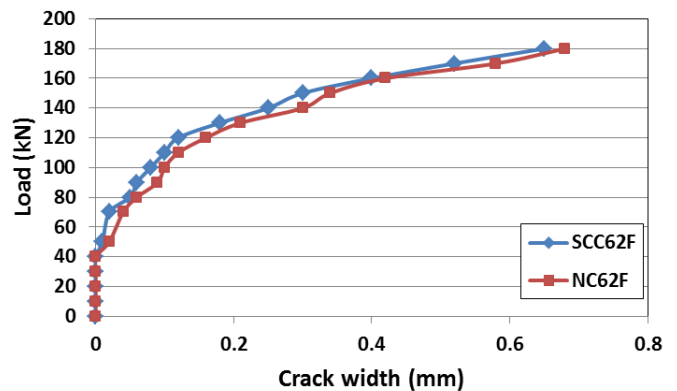

Figure (8) - Load- crack width curve for SCC and NC beams failed in flexure

Beams Designed to Fail in Shear with a/d=3 (Slender Beams)

The general behavior (crack development and failure mechanism) of SCC and NC beams was quite similar. First, the flexural cracks initiated in the pure bending region. With further increase of load new flexural cracks formed in the shear spans and extended toward the loading points. The failure in these specimens was always sudden and in diagonal tension shortly after diagonal shear cracks appeared. It was noticed that the ultimate shear capacity of these beam elements was only slightly higher than the load which caused diagonal cracking. It is for this reason that no diagonal tension cracks could be measured

Table (4) - Test results of beams designed to fail in flexure

Beam	Cracking load (kN) (1)	Ultimate load (kN) (2)	Ratio (1)/(2) %	Ultimate moment kN.m (3)	Calculated moment kN.m (4)	Ratio (3)/(4)	Service Load (kN)	Measured Deflection at service load(mm) (5)	Calculated Deflection at service load(mm) (6)	Ratio (5)/(6)
SCC30F	40	163	25.0	64.0	49.39	1.296	101.87	3.48	3.50	0.99
SCC50F	42	172	24.4	67.6	50.98	1.326	107.50	3.59	3.66	0.98
SCC62F	45	187.5	24.0	73.7	51.85	1.421	117.19	3.67	3.88	0.95
NC30F	35	162	21.6	63.7	49.26	1.293	101.25	3.39	3.48	0.97
NC50F	37.5	170	22.1	66.8	51.03	1.309	106.25	3.55	3.60	0.98
NC62F	40	187.5	21.3	73.7	51.86	1.421	117.19	3.60	3.77	0.95

Table (5) - Test results of beams designed to fail in shear with a/d=3 (Slender Beams)

Beam	Flexural cracking load (kN) (1)	Ultimate load(kN) (2)	Ratio (1)/(2) %	Predicted ultimate load (kN)			Ratio (2)/(3)	Ratio (2)/(4)	Ratio (2)/(5)
				ACI (3)	EC-2 (4)	BS8110 (5)			
SCC30S	41	110	37.27	76.4	97.8	92.7	1.44	1.13	1.17
SCC50S	42	130	32.30	91.6	110.3	103.0	1.42	1.18	1.26
SCC62S	46	151	30.46	106.0	122.1	113.2	1.42	1.24	1.33
NC30S	36	119	30.25	75.8	97.3	93.1	1.57	1.22	1.28
NC50S	38	137	27.70	93.1	111.5	104.2	1.47	1.23	1.31
NC62S	43	150	28.70	105.7	121.4	113.6	1.42	1.23	1.32

Table (6) - Test results of beams designed to fail in shear with a/d=1 (Deep Beams)

Beam	Flexural cracking load(kN) (1)	Shear cracking load(kN) (2)	Ultimate load(kN) (3)	Ratio (1)/(3) %	Ratio (2)/(3) %	Predicted ultimate load (kN)			Ratio (3)/(4)	Ratio (3)/(5)	Ratio (3)/(6)
						ACI (4)	EC-2 (5)	BS8110 (6)			
SCC30D	145	174	520	27.9	33.5	333.55	195.53	185.150	1.56	2.66	2.80
SCC50D	177	210	588	30.1	35.7	479.40	220.66	250.50	1.22	2.66	2.86
SCC62D	190	220	620	30.6	35.4	546.49	243.30	226.60	1.13	2.55	2.74
NC30D	134	151	510	26.3	29.6	328.45	194.53	185.60	1.55	2.62	2.75
NC50D	170	200	580	29.3	34.5	490.64	222.37	208.00	1.18	2.61	2.79
NC62D	185	217	620	29.8	35.0	546.49	243.17	226.70	1.13	2.55	2.73

Table (7) - Test results of slabs designed to fail in punching shear

Slab	First cracking load (kN) (1)	Ultimate load (kN) (2)	Ratio (1)/(2) %	Predicted ultimate load (kN)			Ratio (2)/(3)	Ratio (2)/(4)	Ratio (2)/(5)
				ACI (3)	EC-2 (4)	BS8110 (5)			
SCC30	35	147.5	23.7	68.79	86.25	104.66	2.11	1.71	1.40
SCC50	38	158.0	24.0	82.70	97.50	117.12	1.91	1.62	1.35
SCC62	50	189.0	26.5	95.11	107.02	127.08	1.99	1.77	1.49
NC30	32	124.0	25.8	68.16	85.72	105.28	1.82	1.44	1.18
NC50	36	130.0	27.7	83.30	97.99	117.40	1.56	1.33	1.02
NC62	40	170.0	23.5	95.27	107.13	127.56	1.78	1.58	1.33

prior to failure. It is observed that beams of series (SCC) show almost the same crack pattern and failure mechanism as beams (NC) as shown in Fig. (9), where all beams failed due to diagonal tension shear. The diagonal cracking load was close to the ultimate load, the diagonal crack that causing failure started suddenly from the last flexural crack that became inclined and crossed mid depth, and then such a crack propagated simultaneously towards the load-point and towards the support along the tensile reinforcement (due to dowel action) causing a loss of bond and failure of the beam.

For the ultimate load of SCC and NC beams with f_c' of about 62 MPa, SCC beams showed almost the same ultimate load values. That means that, there is no significant effect for change the type of concrete (SCC and NC) on the ultimate shear strength of high strength concrete. It is generally acknowledged that the pattern of crack formation in high-strength concrete is significantly different from that seen with normal strength concrete. High-strength concrete tends to be more brittle, with cracks forming through the aggregates rather than around them. The result could be a smoother fracture plane with subsequently less aggregate interlock.

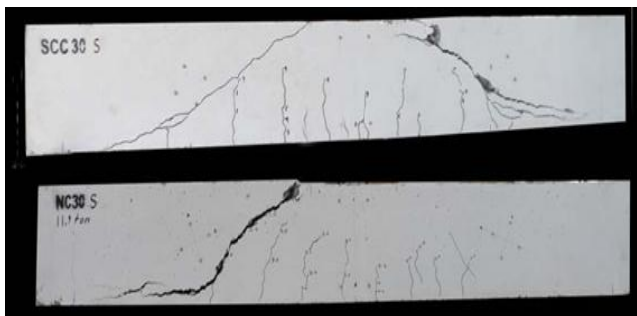

Figure (9) - Crack pattern of SCC and NC slender beams failed in shear

However, from Table (5) it can be observed that the ultimate load increases with increasing in f_c' for both two types of concrete, where beam (SCC50S) exhibited (18.2 %) higher ultimate load than beam (SCC30S), and beam (SCC62S) showed (37.3%) higher ultimate load compared with beam (SCC30S). While the ultimate load of beams (NC50S) and (NC62S) higher than beam NC30S by (15.1%) and (26%) respectively. This is attributed to that, after an inclined crack occurred, the dowel force in the longitudinal reinforcement began resisting shearing displacement at the crack, and that resistance tended to raise tensile stresses in the tension steel surrounding concrete. When stresses exceeded concrete tensile strength, they produced splitting cracking along the reinforcement and a failure in the tension zone. Therefore, the dowel force increases with increasing f_c' , since increasing f_c' will increase the tensile strength of concrete.

It can be concluded that the effect of concrete compressive strength is more pronounced for beams failed in shear than those failed in flexure.

From Fig.(10) it can be observed that, beams of group (SCC) exhibit slightly more midspan deflection than similar beams of group(NC) at all loading stages. The increase in deflection for beams (SCC) is attributed to the lower modulus of elasticity of self-compacting concrete used in making these beams. The deflections of both SCC and NC beams decrease with increase of concrete compressive strength.

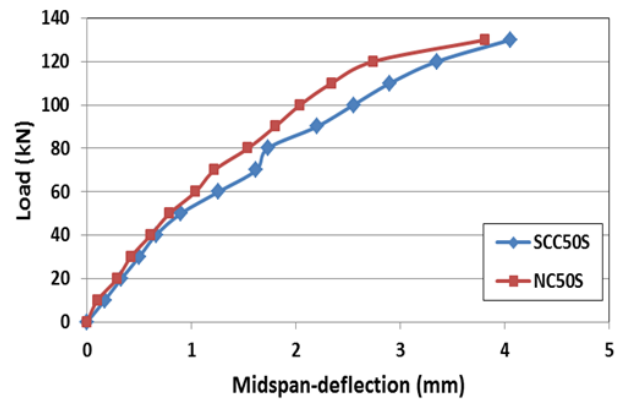

Figure (10) . Load – midspan deflections curve for SCC and NC slender beams failed in shear.

To estimate shear resistance of beams, standard codes and researchers have specified different formulae which take different parameters into consideration. The parameters considered are varying for different codes and researchers leading to disagreement between researchers, making it difficult to choose an appropriate model or code for predicting shear resistance of reinforced concrete. For slender beams without web reinforcement, the following equations were recommended for the prediction of shear force and the results are summarized in Table (5):

- 1- In the **ACI 318-11**Code[14] code, the calculations are based on the simple equation:

$$17\sqrt{f} \dots\dots\dots(4)$$

- 2-The **Eurocode2-2004**[15] recommended the following formula to calculate shear strength:

$$\dots\dots\dots(5)$$

Where:

- V_n = the nominal shear force provided by concrete, N
- b_w = web width, mm
- ρ = bending reinforcement ratio (with a maximum value of 0.02).
- d = effective depth, mm
- f_c' = the compressive strength of the concrete MPa,(not greater than 50 MPa)
- k = factor accounting for size effect defined by the following expression:

$$\sqrt{\frac{F}{b_w d}}$$

- 3-The equation presented in the British standards institution code of practice for design and construction (**BS8110-97**)[16] is as follows:

$$\dots\dots\dots(6)$$

Where

- V_n = the nominal shear force provided by concrete, N
- b_w = web width, mm.
-)should not be taken as less than 1.
- ρ = bending reinforcement ratio.(not greater than 3%).
- For characteristic concrete strengths of cube greater than 25 N/mm², the value of (V_n) in this should be multiplied by $(f_{cu}/25)^{0.33}$. The value of f_{cu} should not be taken as greater than 40 MPa.

In order to compare between these design equations [Eqs. (4) to

(6)] in predicting the ultimate shear of SCC and NC beams, these equations were applied to the 6 test results of SCC and NC beams failing in shear. The relative shear strength values, RSSV (V_{TEST}/V_{PRED}) were found using these equations. It is noticed EC-2 equation gave RSSV smaller than that from the equations of ACI Code and B.S8110 for both types of concrete. All equations are essentially conservative for SCC and NC beams as shown in Table (5).

Beams Designed to Fail in Shear with $a/d=1$ (Deep Beams)

At low load levels, all tested beams behaved in elastic manner. At the first stages of loading, the beams were free from cracks, the deflections were small and proportional to the applied load, consequently the stresses were small and full cross section was active in carrying the loads.

Generally, at 26 to 31 % of failure load, the first cracks were flexural cracks and developed in the region of maximum bending moment at the bottom of the beam, and extended nearly vertically upward, but these cracks were few with so small width but did not propagate upwards despite of increasing the load. Then, a first shear cracks is appeared, at 30 to 36 % of failure load, the first shear crack was occurred and developed suddenly along the line between the load point and supports (interior edge of plates) with small width. But this load did not cause failure, as in slender beams. This means that, there is reserve strength in these deep beams after the appearance of shear crack. The inclined crack became wider gradually with increasing load. At load levels close to failure, a second parallel inclined crack appeared closer to the support than the first one and extended upwards and as load increased. The final failure is due to the destruction of the portion of concrete between these two cracks which acts like a strut between the load and the support points. In some cases crushing of the regions near the load and the support points occurs. For the two types of concrete beams, the failure modes were compression strut failure (diagonal compression failure).

For all tested beams, the first cracks were flexural cracks; comparison is performed with first cracking load for SCC and NC deep beams. SCC beams showed about (2.7- 8.2%) higher flexural cracking loads than comparable NC beams. This may be attributed to that the modulus of rupture of self compacting concrete is greater than that of conventional concrete. These ratios less than which in slender beams failed in shear, this means that as the a/d ratio increases, the effect of difference in modulus of rupture values on the first crack becomes smaller.

For the shear cracking load, beam (SCC30D) showed 15.2% higher shear cracking load compared with beam (NC30D), beam (SCC50D) exhibited 5.0 % higher shear cracking load than beam (NC50D), beam (SCC62D) showed 1.3 % higher shear cracking load than beam (NC62D). This may be attributed to that the splitting tensile strength of self-compacting concrete is greater than that of conventional concrete.

The first shear cracking load increases with the increase in compressive strength of concrete for both two types of concrete (SCC and NC) as shown in Table(3), where the first shear cracking load of beams (SCC50D) and (SCC62D) is higher than that of beam (SCC30D) by 22% and 31% respectively. The first shear cracking load of beams (NC50D) and (NC62D) is greater than that of beam (NC30D) by 26.8% and 38% respectively. This is attributed to that the tension strength of concrete increase with increasing the compressive strength.

For the ultimate load of SCC and NC deep beams, SCC beams give almost the same ultimate load values for a given concrete

compressive strength. That means that there is no significant effect for change of the concrete type on the ultimate shear strength of deep beams. The failure mechanism of deep beams was arch rib failure, where which depends on resistance of the inclined strut. The strength of that strut depends on the compressive strength basically. The beams exhibited reserve in shear strength above that causing diagonal tension cracks, this is due to a type of arching action that forms between the top load and bottom supports after the crack pattern was fully developed. In other words, the load carrying mechanism changed from beam to arch action after the crack pattern was fully developed.

From the experimental results of the ultimate load of slender beams (with $a/d = 3$) and deep beams (with $a/d = 1$), it can be noticed the shear strength increased approximately 433% with decreasing a/d from 3 to 1. This is because arch action increases with reduction of a/d .

Both types of deep beams (SCC and NC) showed almost the same crack pattern and failure mode. Fig.(11) shows typical crack pattern for selected beams.

Figure (12) presents typical flexural cracks width load relations, the flexural cracks was the first to appear, but it was stopped after the emergence of inclined shear crack. The NC beams have flexural cracks width slightly greater than same SCC beams but the number of cracks in SCC beams is greater than NC beams. At the same load, it can be observed that, the flexural crack width decreases with increasing f_c' in both types of concrete.

From Fig.(13) it can be noticed that, at same load stage, the shear crack width of NC beams is more than SCC beams, this may be because the first shear cracking load of SCC beams was greater than that of NC beams.

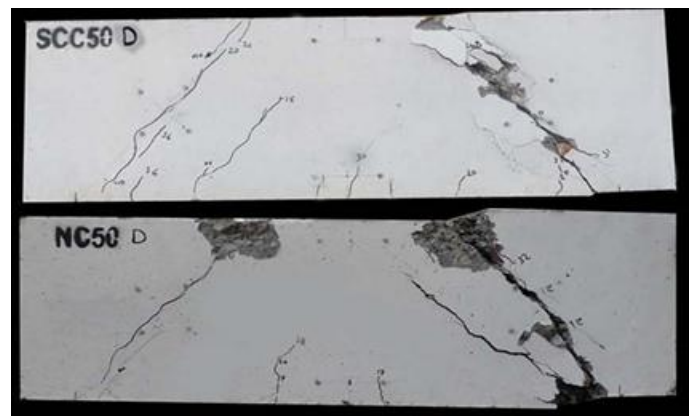

Figure (11) - Crack pattern of SCC and NC deep beams failed in shear

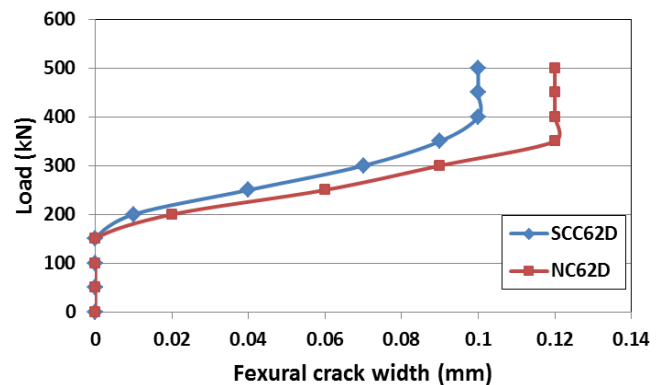

Figure (12)-Load –flexural crack width curve for SCC and NC beams failed in shear.

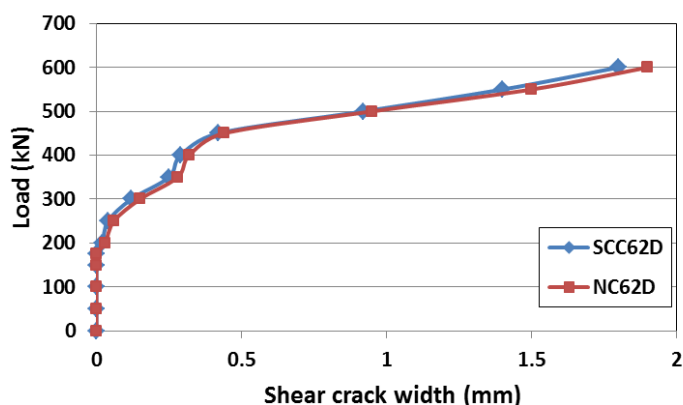

Figure (13): Load –inclined crack width curve for SCC and NC deep beams failed in shear.

For deep beams without web reinforcement, the following equations were recommended for the prediction of shear force and shown in Table (6):

1-In the **ACI 318-11**Code[14], deep beams calculations are based on the nonlinear analysis or strut-and-tie models (STM), The STM is an equilibrium method of limit analysis and design and is adopted in this study:

2-The **Eurocode 2- 2004** (EC-2) [15] recommended the following equation for estimating the shear strength of deep beams ($- \leq 2$):

$$\dots \dots \dots d \dots \dots \dots (7)$$

3-The equation presented in the British standards institution code of practice for design and construction (**BS8110-97**)[16] for estimate shear strength of deep beams($-$ is as follows:

$$\dots \dots \dots d \dots \dots \dots (8)$$

Where

a = shear span,mm

The shear strengths of deep beams made with NC and SCC were calculated in accordance with these equations. The predicted values were compared with the present experimental data. In this study as shown in Table (6), all equations are essentially conservative for SCC and NC beams as shown in Table(6).In addition, the comparative study exhibited that the experimental results were approximately from 2.73 to 2.86 times greater than those results predicted by BS8110. The shear strengths of the SCC and NC specimens were approximately 2.8 and 2.76 times greater than the predicted results, respectively. It was concluded that the use of BS8110 equation was very conservative.

4.4 Slabs Designed to Fail in Punching Shear

The general behavior (crack pattern and failure mechanism) of SCC and NC slabs was all nearly identical, when the load was applied to the slab specimen, the first visible crack (bending cracks) was observed at the tension face of the tested slab at load level equal to (23.5-27.7)% of the ultimate load. In all slabs, cracking on the tensile face began near the center and radiated towards the edges (semi- random phenomena). As the load was increased the cracking propagated to the opposite face. At higher loads, the already formed cracks get widened while new cracks started to form. The new formed cracks were roughly semi-circular or elliptical in shape and occurred in the tension surface of the slab. Failure of the slab occurred when the cone of failure radiating outward from the point of load application pushed up through the slab body (brittle failure with limited warning). At

failure, the slab was no longer capable of taking additional load.No cracks were observed in the compression face of any slab, except those which were observed around the loaded area at failure, which were almost the same as that of the loading plate dimensions. Figure (14) shows the crack pattern on the tension face of selected slabs.

Test results showed that, for the both types of concrete (SCC and NC) the cracking and ultimate loads have a tendency to increase with increasing of f_c' , the observed first cracking load of all tested slabs was approximately (23.5-27.7 %) of the ultimate load, as shown in Table (7).From table (7), it can be observed that, in SCC group, the slab(SCC50) exhibited (9%) higher first cracking load than slab (SCC30), slab (SCC62) showed (42.8%) higher first cracking load than slab (SCC30). The ultimate load of slabs (SCC50) and (SCC62) was higher than of slab (SCC30) by 7.1% and 28.1%, respectively. But in NC group, slab(NC50) exhibited (12.5%) higher first cracking load than slab (NC 30), slab (NC62) showed (25%) higher first cracking load than slab (NC30). The ultimate load of slabs (NC50) and (NC62) was higher than that of slab (NC30) by 4.8% and 37%, respectively.



Figure (14) - Crack pattern of SCC and NC slabs failed in punching shear

It can be seen from Table (7) that, the first cracking load of slabs (SCC30), (SCC50), and (SCC62) was higher than that of slabs (NC30), (NC50), and (NC62) by 9.3%, 5.5%, and 25% respectively. While the increasing in the ultimate load was 19%, 21.5%, and 11.25% respectively. This may be attributed to that SCC has tensile and bond strength and the dowel force higher than those of NC, as well as the vibration effect is eliminated in SCC. Therefore, SCC is more affective in casting of the shallow members than NC

Figure (15) demonstrates that, in the first stages of loading, the deflection of NC group was less than of that SCC group until the first crack loads; this can be attributed to the lower modulus of elasticity of SCC. But, beyond the first cracking load, the deflection of NC and SCC slabs was approximately similar with the increment in load. It is found that, the slabs were capable of undergoing a significant amount of central deflections prior to failure, which approximately equals to (L/116, L/92, L/78, L/122, L/120, and L/117) for slabs (SCC30), (SCC50), (SCC62), (NC30), (NC50), and (NC62), respectively(where L is clear span of the slab).

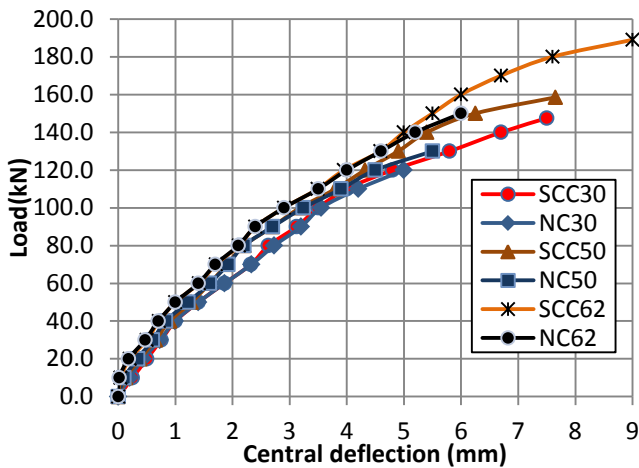

Figure (15) - Comparison of load - central deflection curves for all slabs

Generally, punching strength is predicted by considering a nominal shear stress, a control perimeter and an effective depth. The main differences of approaches depend on the assumed location of the different control perimeter, concrete strength contribution, the size effect and the reinforcement ratio. Depending on the method used, the critical section to check punching shear in slabs is usually situated between 0.5 to 2 times the effective depth from the edge of the load or the reaction. The provisions of three building codes, **ACI 318-11Code** [14], **Eurocode 2 -2004**[15], and **BS8110-1997**[16] are considered.

1-According to **ACI 318M-11 Code** [14] the nominal shear strength shall be taken not greater than any of the following three equations:

$$7 \left(1 - \frac{d}{b_0} \right) \sqrt{f_c'} \quad \text{-----(9)}$$

$$\frac{V_n}{b_0 d} \leq \sqrt{f_c'} \quad \text{-----(10)}$$

$$\sqrt{f_c'} \quad \text{-----(11)}$$

Where

V_n = the nominal shear force provided by concrete, N

f_c' = the compressive strength of the concrete, MPa

d = effective depth, mm

b_0 = the perimeter of the critical section ,{4(c + d)} for square column, mm

c = side length of column, mm.

β = the ratio of the long side to the short side of the concentrated load or reaction area,

α = a factor for slab column connections based on the location of the column (40 for interior, 30 for exterior, 20 for corner columns).

2-The **Eurocode 2 - 2004** [15] recommends the following expression to estimate punching shear strength of slabs:

$$\frac{V_n}{b_0 d} \leq \dots \text{-----(12)}$$

Where:

V_n = the nominal shear force provided by concrete, N

b_0 = control perimeter located 2d from the face of the column, {4(c + π d)} for square column, mm,

c = side length of column, mm.

ρ = bending reinforcement ratio (not greater than 0.02)

d = effective depth, mm

f_c' = the compressive strength of the concrete MPa,(not greater than 50 MPa)

k = factor accounting for size effect defined by the following expression:

$$3\text{-The equation presented in BS8110-97 [16] is as follows:}$$

$$\frac{V_n}{b_0 d} \leq \dots \text{-----(13)}$$

Where

V_n = the nominal shear force provided by concrete, N

b_0 = control perimeter located 1.5d from the face of the column, { 4(c + 3 d)}for square column, mm.

c = side length of column, mm.

—)should not be taken as less than 1.

ρ = the ratio of steel within 1.5d of column face.(not greater than 3%)

For characteristic concrete strengths of cube greater than 25 N/mm², the value of V in this should be multiplied by $(f_{cu}/25)^{0.33}$. The value of f_{cu} should not be taken as greater than 40 MPa.

The experimental results are compared with design models of the **ACI 318-11Code**[14], the **Eurocode 2-2004** [15] and **BS8110-1997**[16] in predicting the punching shear strength of SCC and NC slabs, these equations have been applied to calculate the punching shear strength for three SCC and three NC slabs failing in punching shear. The relative shear strength values (RSSV) (V_{TEST}/V_{PRED}) were found using these equations. All equations are essentially conservative for SCC and NC slabs as shown in Table (7).

Conclusions

From the test results obtained in this study the following conclusions can be drawn:

1- For beams designed to fail in flexure, beams made with SCC showed 11.6% higher cracking load than similar beams made with NC. For the ultimate load, no considerable difference between NC and SCC beams was observed.

2-For slender beams (a/d=3) failed in shear, SCC beams exhibited 10.5% higher flexural cracking load than NC beams. For the ultimate load and for beams with f_c' of about 32 and 48 MPa, NC beam showed 6.75 % higher ultimate load compared with SCC beams. For the ultimate load of SCC and NC beams with f_c' of about 62 MPa, SCC beam gave almost the same ultimate load value.

3-For deep beams (a/d=1) failed in shear and for the inclined cracking load, SCC beams exhibited 7.3 % higher inclined cracking load compared with similar NC beams. For the ultimate load, no considerable difference between NC and SCC beams was noticed.

4-A significant increase in ultimate shear load was obtained by reducing the a/d ratio. For SCC beams without web reinforcement, an increase of (433 %) was obtained by reducing the a/d ratio from 3 to 1.

5- For slabs failed in punching shear, SCC slabs exhibited 16.6 % higher flexural cracking load than similar NC slabs. For the ultimate load, SCC slabs exhibited 17.25% higher ultimate load than similar NC slabs.

6- The number of flexural cracks in all NC beams was lower than the similar SCC beams, but those cracks were narrower in SCC beams. For the same loading level, SCC beams deflection was slightly more than similar NC.

References

1. Broomfield, J.2003.,“ The identification and assessment of defects damage and decay”. In S. MacDonald (Ed.), Concrete:Building pathology. Oxon: Blackwell,
2. Sonebi, M., Tamimi, A. K. and Bartos, P. J. M., 2003,“Performance and Cracking Behavior of Reinforced Beams Cast with Self-Consolidating Concrete”, ACI Material Journal, Vol. 100, No.57, May-June, pp. 492-500.
3. Schiessl, A. and Zilch, K., 2001, “The Effects of the Modified Composition of SCC on Shear and bond Behavior”, Proceedings of the second RILEM international symposium on self-compacting concrete, Ozawa, K. and Ouchi M. Editors, Kochi University of Technology, Japan: COMS Engineering Corporation, pp. 501-506
4. Hassan, S.A., 2012, “Behavior of Rreinforced Concrete Deep Beams using Self Compacting Concrete” Ph.D. Thesis, College of Engineering, Baghdad University, March 156 pp.
5. Iraqi Standards No.45/1984,"Aggregate from Natural Sources for Concrete and Construction", Ministry of Housing and Construction, Baghdad.
6. ASTM C494-04, 2004 “Standard Specification for Chemical Admixtures for Concrete”, Vol. 4.2, pp. 1-9.
7. ASTM C143 M-03, “Standard test method for slump of hydraulic cement concrete”, Vol. 4.2, 2003, pp. 1-5.
8. EFNARC, 2005 “The European Guidelines for Self Compacting Concrete Specification, Production and Use”, European Federation of Producers and Applicators of Specialist Products for Structures, May.
9. ASTM C39/C39M-2003, “Standard Test Method for Compressive Strength of Cylindrical Concrete Specimens”, Vol. 4.2, 2003, pp. 1-5.
10. ASTM C496/C496M-04, 2004, “Standard Test Method for Splitting Tensile Strength of Cylindrical Concrete Specimens”, Vol. 4.2, pp. 1-5.
11. ASTM C469-02, 2002, “Standard Test Method for Static Modulus of Elasticity and Poisson's Ratio of Concrete in Compression”, Vol. 4.2, pp. 1-
12. B.S. 1881: Part 116: 1983, “Methods for Determination of Compressive Strength of Concrete Cubes”, January 1983, pp. 1-8.
13. ASTM C78-02, 2002, “Standard Test Method for Flexural Strength of Concrete (Using Simple Beam with Third-point Loading)”, Vol. 4.2, pp. 1-3.
14. ACI Committee-318, “Building Code Requirements for Structural Concrete (ACI 318M-11) and Commentary”, American Concrete Institute, Farmington Hills, MI 48331, USA, 2011.
15. Eurocode 2, 2004,“Design of Concrete Structures-Part 1-1, “General Rules and Rules for Buildings”, CEN, EN 1992-1-1, Brussels, Belgium.
16. British Standards Institution (B.S.8110), 1997 “Code of Practice for Design and Construction” British Standards Institution, Part 1, London.